

# MSTB 2,5/ 3-ST-5,08 - PCB connector



1757022

<https://www.phoenixcontact.com/us/products/1757022>

Please be informed that the data shown in this PDF document is generated from our online catalog. Please find the complete data in the user documentation. Our general terms of use for downloads are valid.

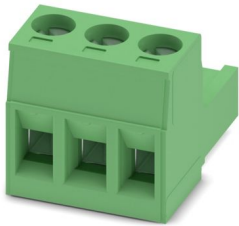

PCB connector, nominal cross section: 2.5 mm<sup>2</sup>, color: green, nominal current: 12 A, rated voltage (III/2): 320 V, contact surface: Tin, contact connection type: Socket, number of potentials: 3, number of rows: 1, number of positions: 3, number of connections: 3, product range: MSTB 2,5/...-ST, pitch: 5.08 mm, connection method: Screw connection with tension sleeve, screw head form: L Slotted, conductor/PCB connection direction: 0 °, locking clip: - Locking clip, plug-in system: COMBICON MSTB 2,5, locking: without, mounting: without, type of packaging: packed in cardboard

## Your advantages

- Well-known connection principle allows worldwide use
- Low temperature rise, thanks to maximum contact force
- Allows connection of two conductors

## Commercial data

Item number	1757022
Packing unit	100 pc
Minimum order quantity	100 pc
Sales key	AA03
Product key	AACAGC
Catalog page	Page 262 (C-1-2013)
GTIN	4017918029555
Weight per piece (including packing)	5.16 g
Weight per piece (excluding packing)	5.153 g
Customs tariff number	85366990
Country of origin	DE

# MSTB 2,5/ 3-ST-5,08 - PCB connector



1757022

<https://www.phoenixcontact.com/us/products/1757022>

## Technical data

### Product properties

Product type	PCB connector
Product family	MSTB 2,5/..-ST
Product line	COMBICON Connectors M
Type	Standard
Number of positions	3
Pitch	5.08 mm
Number of connections	3
Number of rows	1
Number of potentials	3
Mounting flange	without

### Data management status

Article revision	09
------------------	----

### Electrical properties

Nominal current $I_N$	12 A
Nominal voltage $U_N$	320 V
Contact resistance	1.3 m $\Omega$
Rated voltage (III/3)	250 V
Rated surge voltage (III/3)	4 kV
Rated voltage (III/2)	320 V
Rated surge voltage (III/2)	4 kV
Rated voltage (II/2)	630 V
Rated surge voltage (II/2)	4 kV

### Connection data

#### Connection technology

Type	Standard
Connector system	COMBICON MSTB 2,5
Nominal cross section	2.5 mm <sup>2</sup>
Contact connection type	Socket

#### Interlock

Locking type	without
Mounting flange	without

#### Conductor connection

Connection method	Screw connection with tension sleeve
Conductor/PCB connection direction	0 °
Conductor cross section rigid	0.2 mm <sup>2</sup> ... 2.5 mm <sup>2</sup>
Conductor cross section flexible	0.2 mm <sup>2</sup> ... 2.5 mm <sup>2</sup>

# MSTB 2,5/ 3-ST-5,08 - PCB connector



1757022

<https://www.phoenixcontact.com/us/products/1757022>

Conductor cross section AWG	24 ... 12
Conductor cross section flexible, with ferrule without plastic sleeve	0.25 mm <sup>2</sup> ... 2.5 mm <sup>2</sup>
Conductor cross section, flexible, with ferrule, with plastic sleeve	0.25 mm <sup>2</sup> ... 2.5 mm <sup>2</sup>
2 conductors with same cross section, solid	0.2 mm <sup>2</sup> ... 1 mm <sup>2</sup>
2 conductors with same cross section, flexible	0.2 mm <sup>2</sup> ... 1.5 mm <sup>2</sup>
2 conductors with same cross section, flexible, with ferrule without plastic sleeve	0.25 mm <sup>2</sup> ... 1 mm <sup>2</sup>
2 conductors with the same cross section, flexible, with TWIN ferrule with plastic sleeve	0.5 mm <sup>2</sup> ... 1.5 mm <sup>2</sup>
Cylindrical gauge a x b / diameter	2.8 mm x 2.0 mm / 2.4 mm
Stripping length	7 mm
Drive form screw head	Slotted (L)
Tightening torque	0.5 Nm ... 0.6 Nm

## Specifications for ferrules without insulating collar

recommended crimping tool	1212034 CRIMPFOX 6
---------------------------	--------------------

## Specifications for ferrules with insulating collar

recommended crimping tool	1212034 CRIMPFOX 6
---------------------------	--------------------

## Material specifications

### Material data - contact

Note	WEEE/RoHS-compliant, free of whiskers according to IEC 60068-2-82/JEDEC JESD 201
Contact material	Cu alloy
Surface characteristics	hot-dip tin-plated
Metal surface terminal point (top layer)	Tin (5 - 7 µm Sn)
Metal surface contact area (top layer)	Tin (5 - 7 µm Sn)

### Material data - housing

Color (Housing)	green (6021)
Insulating material	PA
Insulating material group	I
CTI according to IEC 60112	600
Flammability rating according to UL 94	V0
Glow wire flammability index GWFI according to EN 60695-2-12	850
Glow wire ignition temperature GWIT according to EN 60695-2-13	775
Temperature for the ball pressure test according to EN 60695-10-2	125 °C

## Dimensions

# MSTB 2,5/ 3-ST-5,08 - PCB connector

1757022

<https://www.phoenixcontact.com/us/products/1757022>

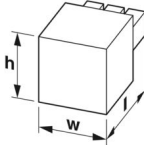
Dimensional drawing	
Pitch	5.08 mm
Width [w]	15.24 mm
Height [h]	15 mm
Length [l]	18.3 mm

## Notes

Notes on operation	In accordance with IEC 61984, COMBICON connectors have no switching power (COC). During designated use, they must not be plugged in or disconnected when carrying voltage or under load.
--------------------	--

## Mechanical tests

### Test for conductor damage and slackening

Specification	IEC 60999-1:1999-11
Result	Test passed

### Pull-out test

Specification	IEC 60999-1:1999-11
Conductor cross section/conductor type/tractive force setpoint/actual value	0.2 mm <sup>2</sup> / solid / > 10 N
	0.2 mm <sup>2</sup> / flexible / > 10 N
	2.5 mm <sup>2</sup> / solid / > 50 N
	2.5 mm <sup>2</sup> / flexible / > 50 N

### Insertion and withdrawal forces

Result	Test passed
No. of cycles	25
Insertion strength per pos. approx.	8 N
Withdraw strength per pos. approx.	6 N

### Torque test

Specification	IEC 60999-1:1999-11
---------------	---------------------

### Resistance of inscriptions

Specification	IEC 60068-2-70:1995-12
Result	Test passed

### Polarization and coding

Specification	IEC 60512-13-5:2006-02
Result	Test passed

### Visual inspection

Specification	IEC 60512-1-1:2002-02
---------------	-----------------------

# MSTB 2,5/ 3-ST-5,08 - PCB connector



1757022

<https://www.phoenixcontact.com/us/products/1757022>

Result	Test passed
Dimension check	
Specification	IEC 60512-1-2:2002-02
Result	Test passed

## Environmental and real-life conditions

### Vibration test

Specification	IEC 60068-2-6:2007-12
Frequency	10 - 150 - 10 Hz
Sweep speed	1 octave/min
Amplitude	0.35 mm (10 Hz ... 60.1 Hz)
Acceleration	5g (60.1 Hz ... 150 Hz)
Test duration per axis	2.5 h
Test directions	X-, Y- and Z-axis

### Durability test

Specification	IEC 60512-9-1:2010-03
Impulse withstand voltage at sea level	4.8 kV
Contact resistance $R_1$	1.3 m $\Omega$
Contact resistance $R_2$	1.4 m $\Omega$
Insertion/withdrawal cycles	25

### Climatic test

Specification	ISO 6988:1985-02
Corrosive stress	0.2 dm <sup>3</sup> SO <sub>2</sub> on 300 dm <sup>3</sup> /40 °C/1 cycle
Thermal stress	100 °C/168 h
Power-frequency withstand voltage	2.21 kV

### Ambient conditions

Ambient temperature (operation)	-40 °C ... 100 °C (dependent on the derating curve)
Ambient temperature (storage/transport)	-40 °C ... 70 °C
Relative humidity (storage/transport)	30 % ... 70 %
Ambient temperature (assembly)	-5 °C ... 100 °C

## Electrical tests

### Thermal test | Test group C

Specification	IEC 60512-5-1:2002-02
Tested number of positions	12

### Insulation resistance

Specification	IEC 60512-3-1:2002-02
Insulation resistance, neighboring positions	> 5 M $\Omega$

### Air clearances and creepage distances |

Specification	IEC 60664-1:2007-04
---------------	---------------------

# MSTB 2,5/ 3-ST-5,08 - PCB connector



1757022

<https://www.phoenixcontact.com/us/products/1757022>

Insulating material group	I
Comparative tracking index (IEC 60112)	CTI 600
Rated insulation voltage (III/3)	250 V
Rated surge voltage (III/3)	4 kV
minimum clearance value - non-homogenous field (III/3)	3 mm
minimum creepage distance (III/3)	3.2 mm
Rated insulation voltage (III/2)	320 V
Rated surge voltage (III/2)	4 kV
minimum clearance value - non-homogenous field (III/2)	3 mm
minimum creepage distance (III/2)	3 mm
Rated insulation voltage (II/2)	630 V
Rated surge voltage (II/2)	4 kV
minimum clearance value - non-homogenous field (II/2)	3 mm
minimum creepage distance (II/2)	3.2 mm

## Packaging specifications

Type of packaging	packed in cardboard
-------------------	---------------------

# MSTB 2,5/ 3-ST-5,08 - PCB connector



1757022

<https://www.phoenixcontact.com/us/products/1757022>

## Drawings

Diagram

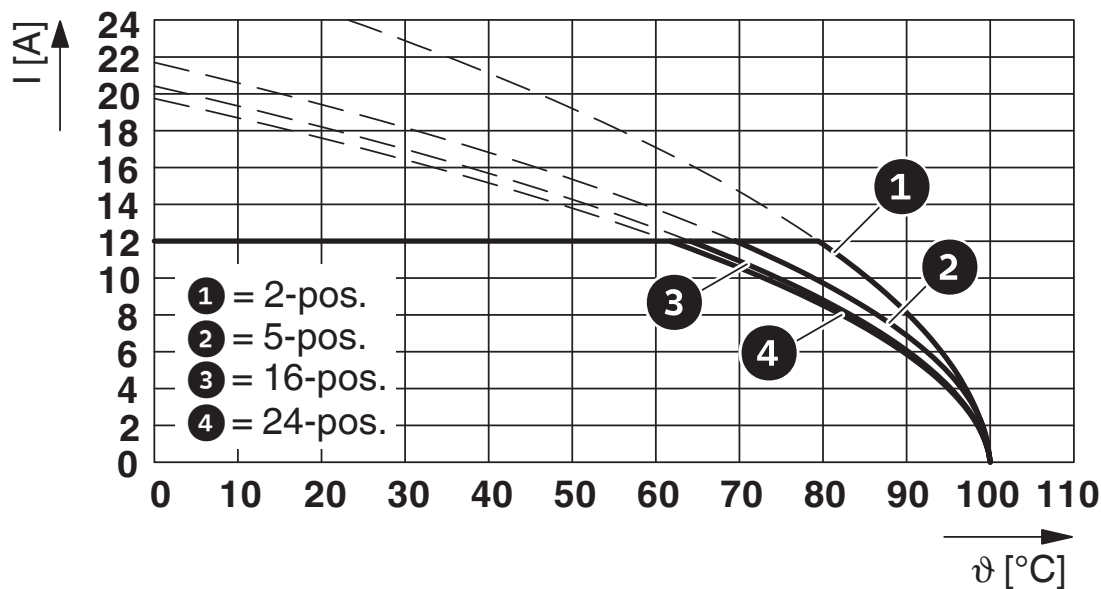

Type: MSTB 2,5/...-ST-5,08 with SMSTB 2,5/...-G-5,08

Diagram

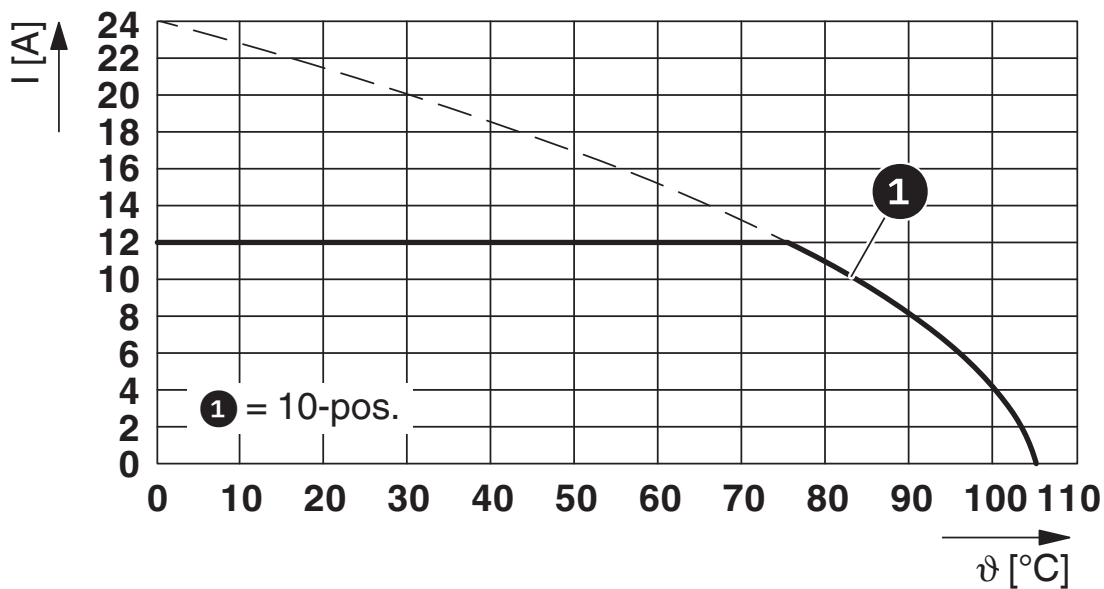

Type: MSTB 2,5/...-ST-5,08 with MSTBHK 2,5/...-G-5,08

# MSTB 2,5/ 3-ST-5,08 - PCB connector



1757022

<https://www.phoenixcontact.com/us/products/1757022>

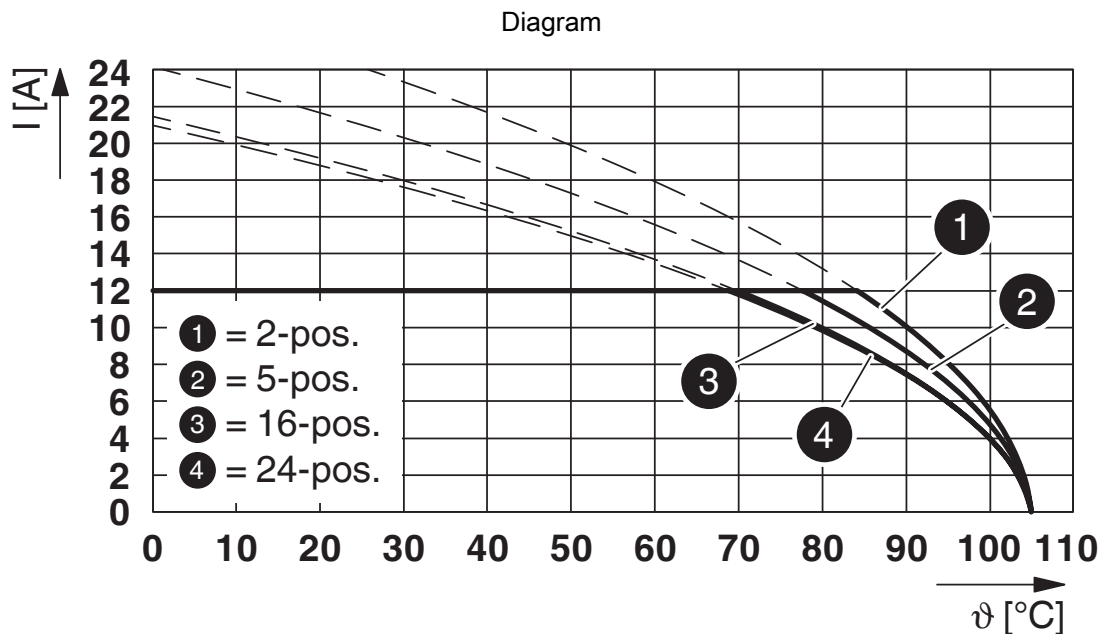

Type: MSTB 2,5/...-ST-5,08 with MSTBA 2,5/...-G-5,08

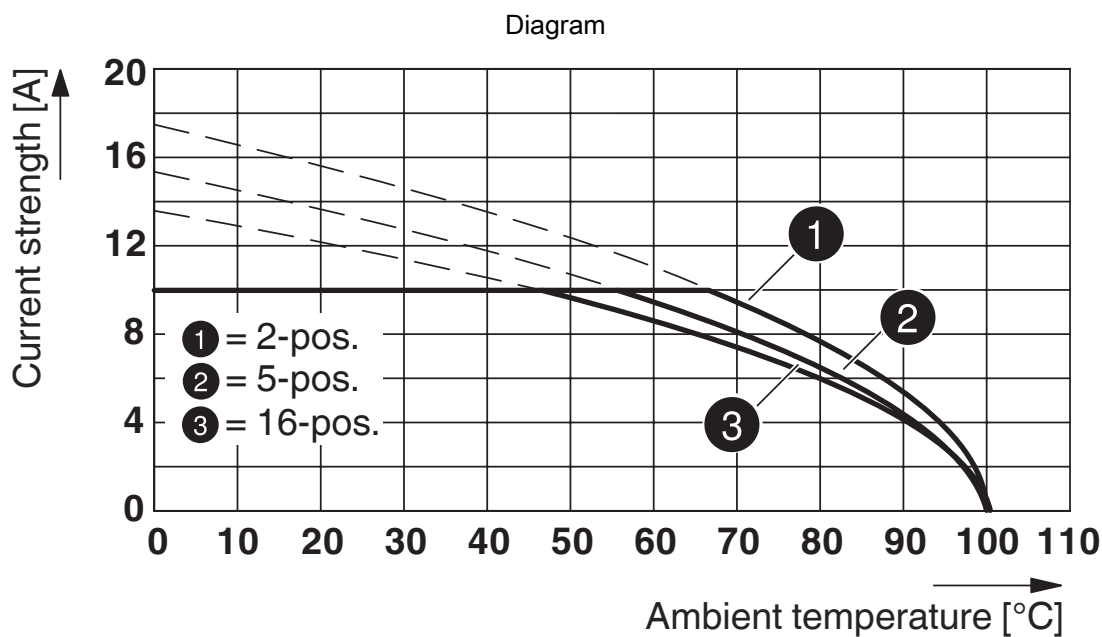

Type: MSTB 2,5/...-ST-5,08 with MDSTBV 2,5/...-G-5,08



# MSTB 2,5/ 3-ST-5,08 - PCB connector



1757022

<https://www.phoenixcontact.com/us/products/1757022>

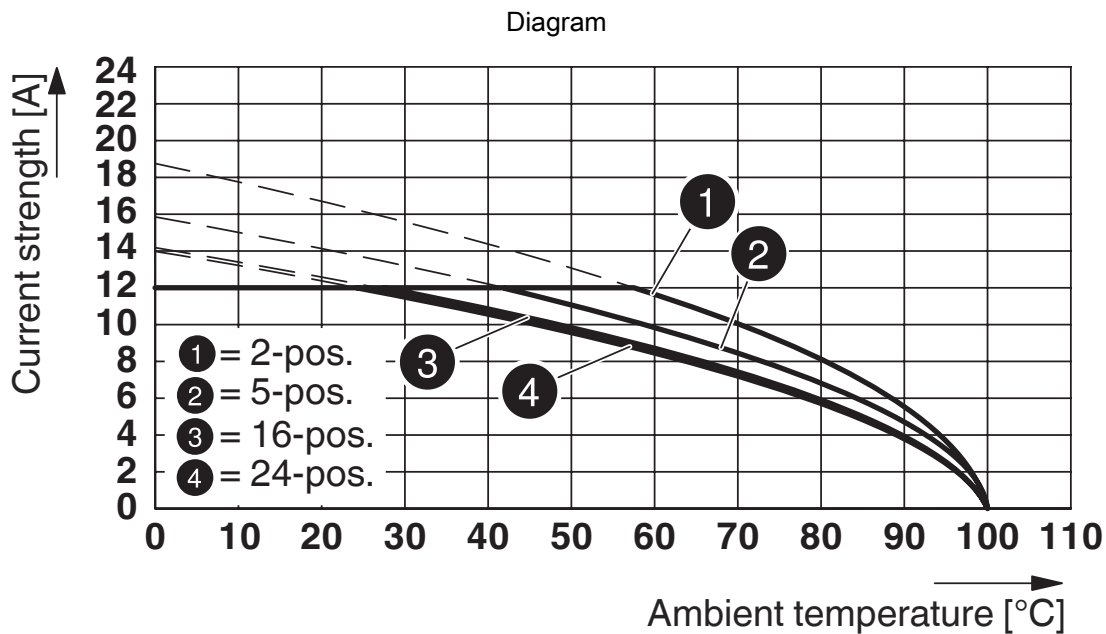

Type: MSTB 2,5/...-ST-5,08 with MSTBVA 2,5/...-G-5,08

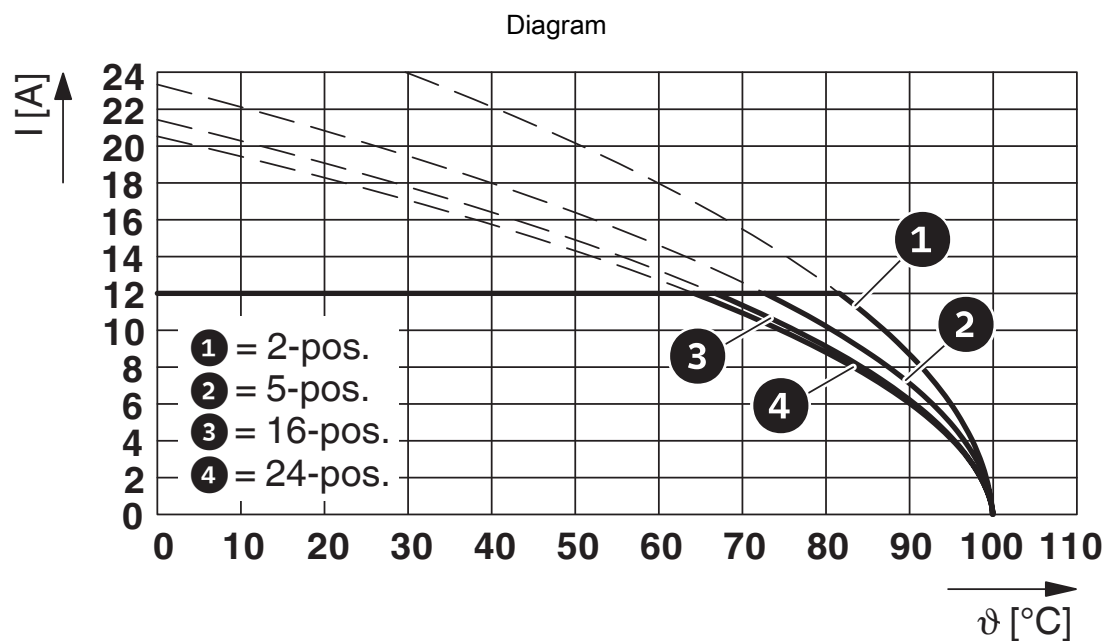

Type: MSTB 2,5/...-ST-5,08 with SMSTBA 2,5/...-G-5,08

# MSTB 2,5/ 3-ST-5,08 - PCB connector



1757022

<https://www.phoenixcontact.com/us/products/1757022>

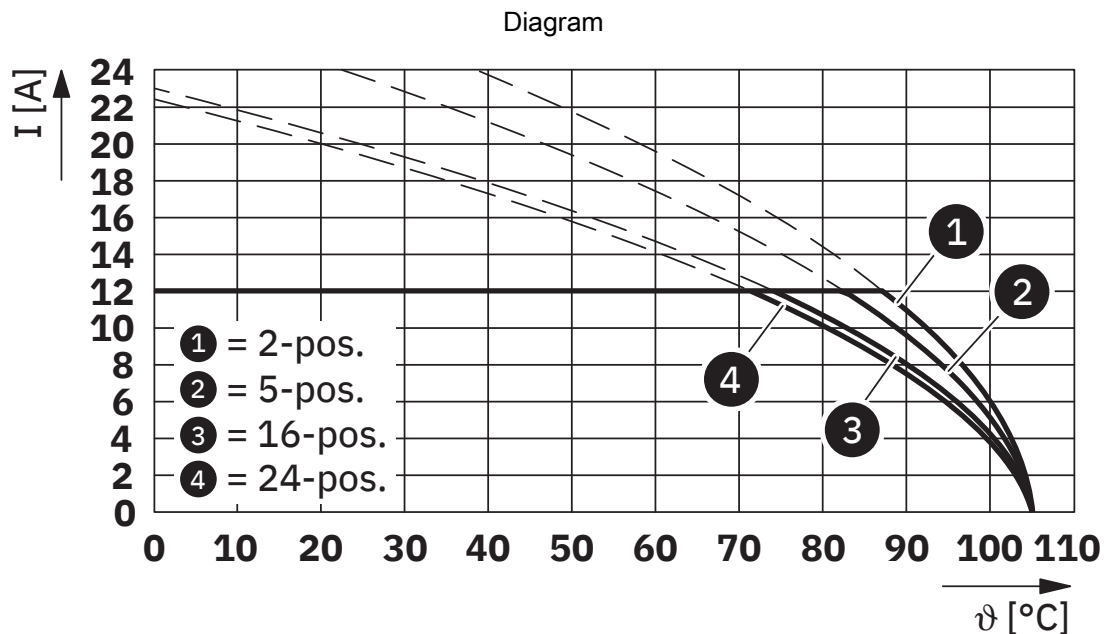

Type: MSTB 2,5/...-ST-5,08 with MSTBVK 2,5/...-G-5,08

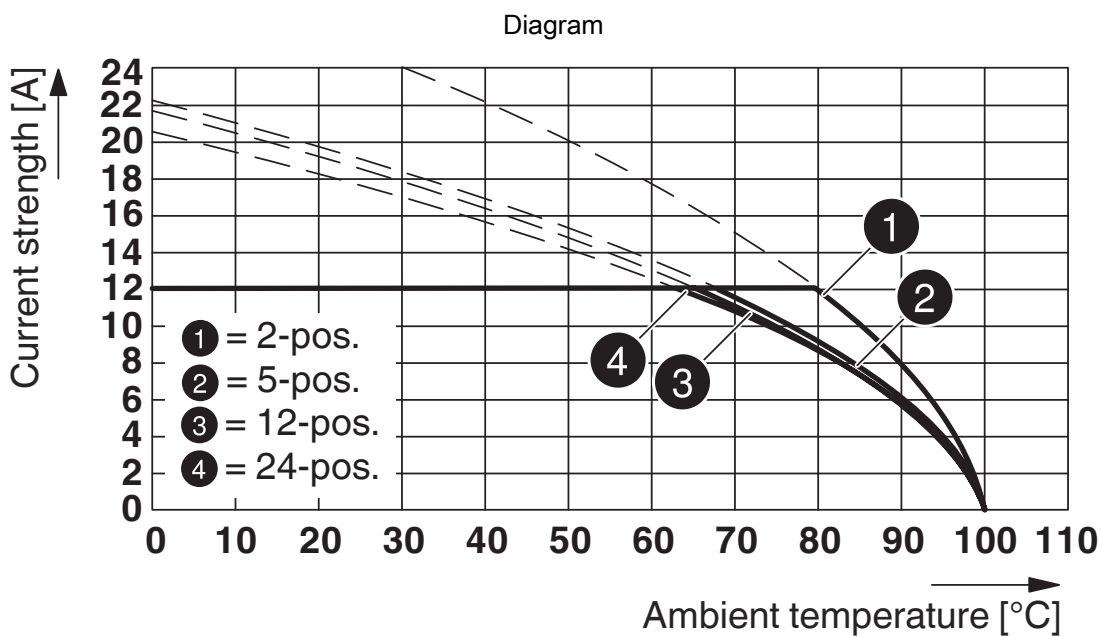

Type: MSTB 2,5/...-ST-5,08 with MSTB 2,5/...-G-5,08

# MSTB 2,5/ 3-ST-5,08 - PCB connector



1757022

<https://www.phoenixcontact.com/us/products/1757022>

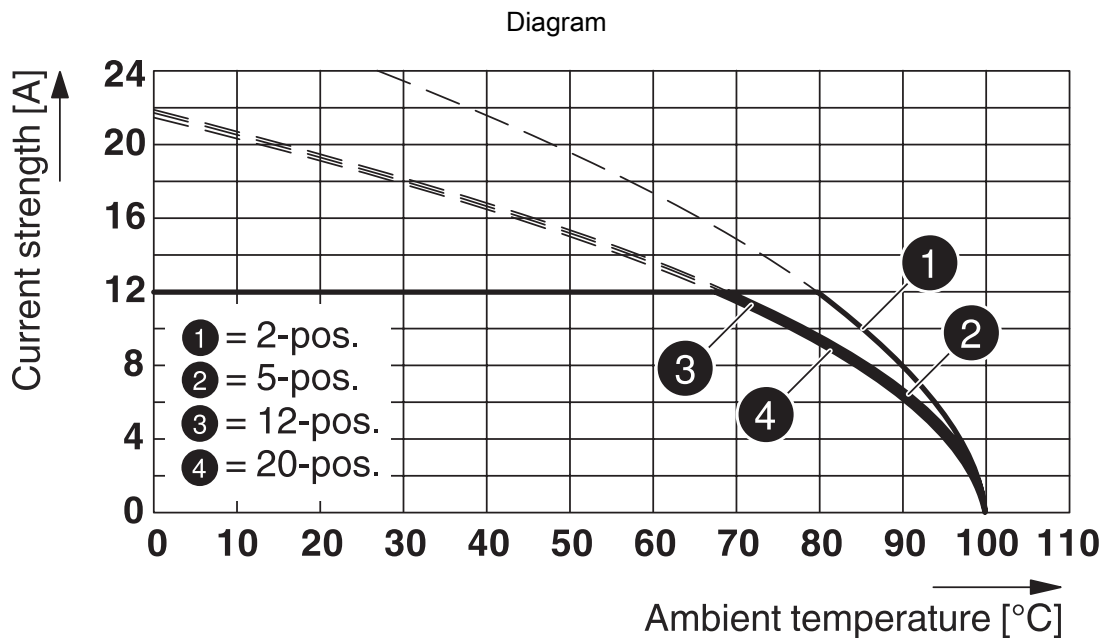

Type: MSTB 2,5/...-ST-5,08 with MVSTBU 2,5/...-GB-5,08

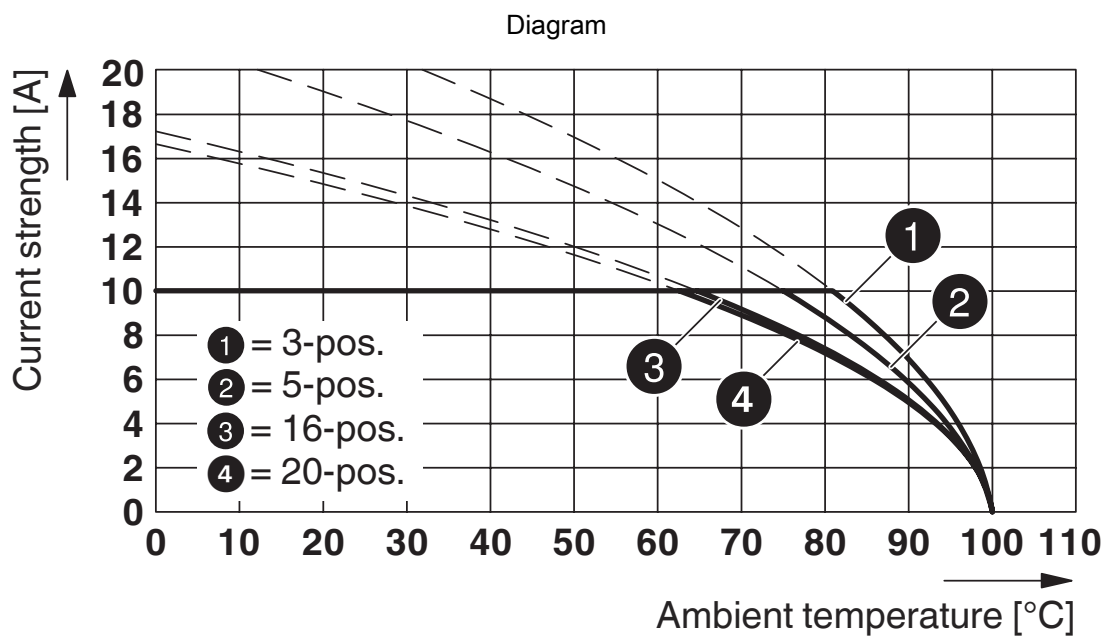

Type: MSTB 2,5/...-ST-5,08 with MDSTBV 2,5/...-G1-5,08

# MSTB 2,5/ 3-ST-5,08 - PCB connector



1757022

<https://www.phoenixcontact.com/us/products/1757022>

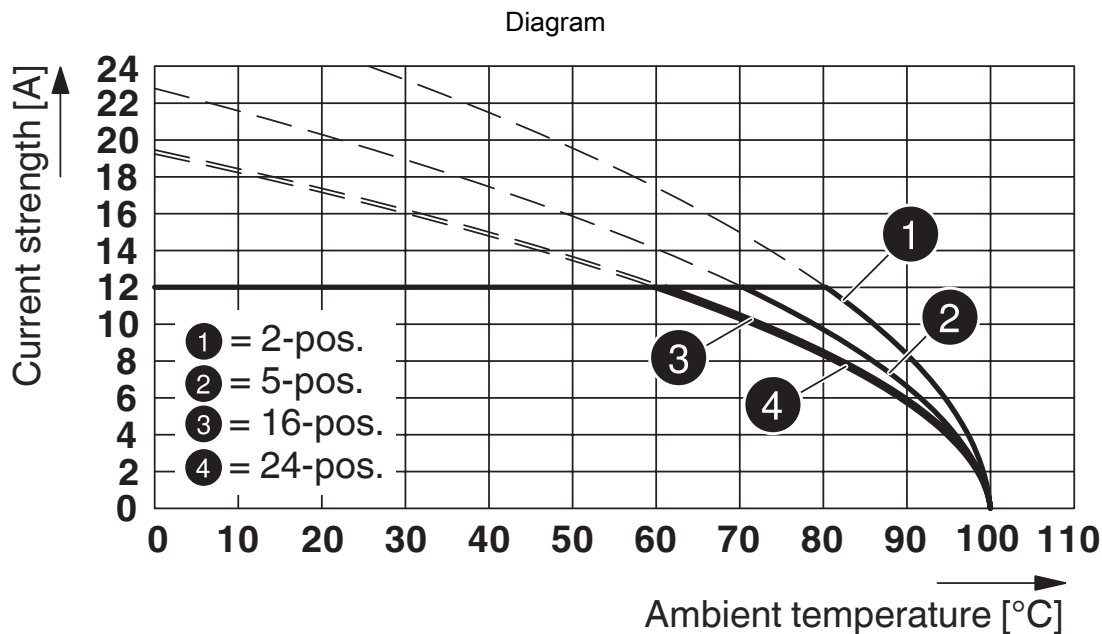

Type: MSTB 2,5/...-ST-5,08 with MSTBW 2,5/...-G-5,08

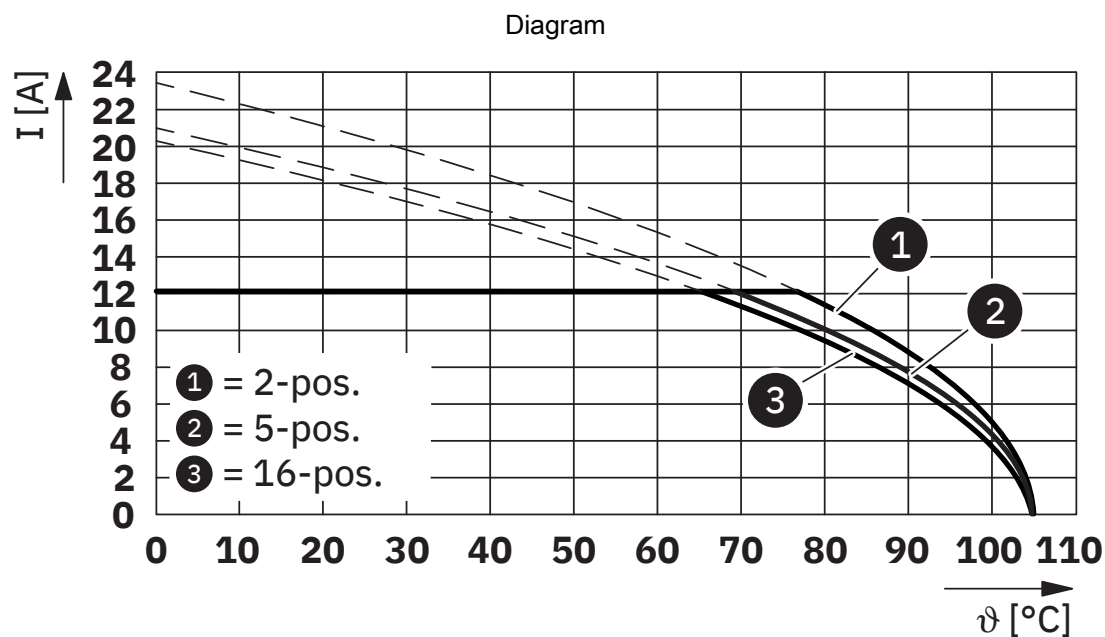

Type: MSTB 2,5/...-ST-5,08 with DFK-MSTB 2,5/...-G-5,08

# MSTB 2,5/ 3-ST-5,08 - PCB connector



1757022

<https://www.phoenixcontact.com/us/products/1757022>

Diagram

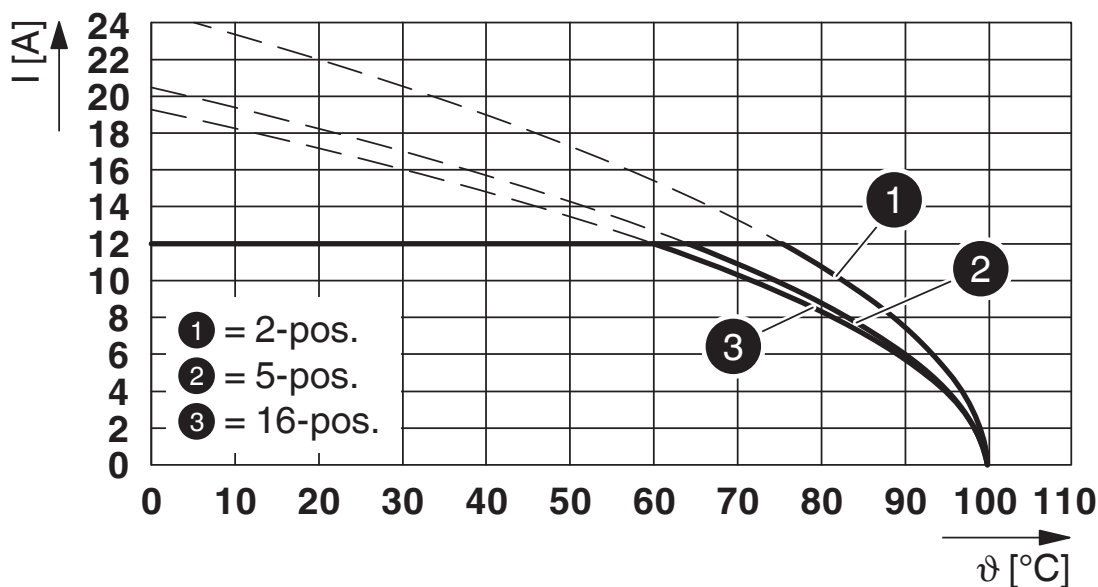

Type: MSTB 2,5/...-ST-5,08 with DFK-MSTBA 2,5/...-G-5,08

Diagram

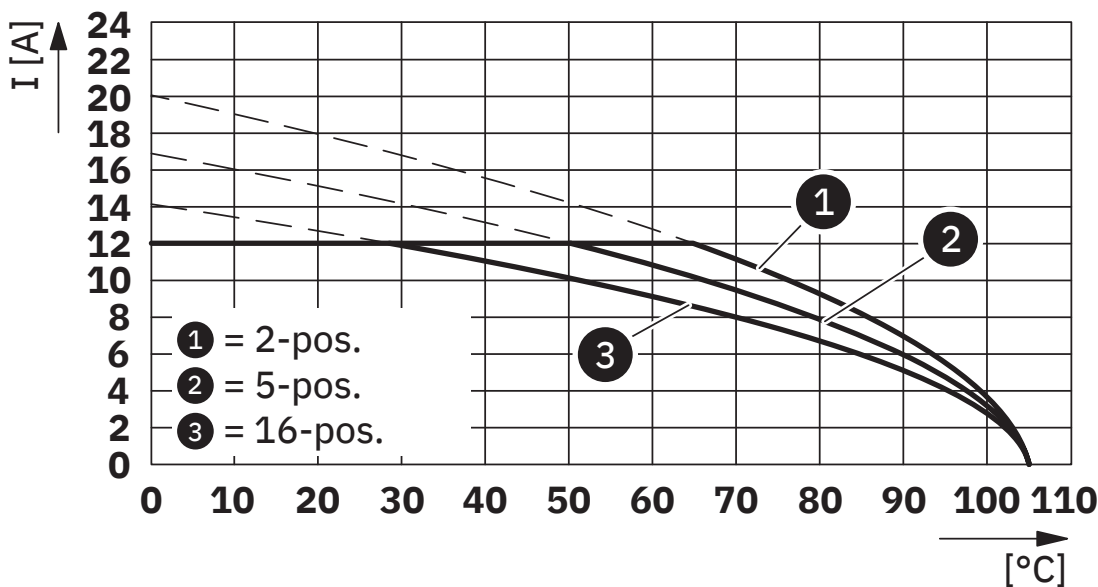

Type: MSTB 2,5/...-ST-5,08 with DFK-MSTBVA 2,5/...-G-5,08

# MSTB 2,5/ 3-ST-5,08 - PCB connector



1757022

<https://www.phoenixcontact.com/us/products/1757022>

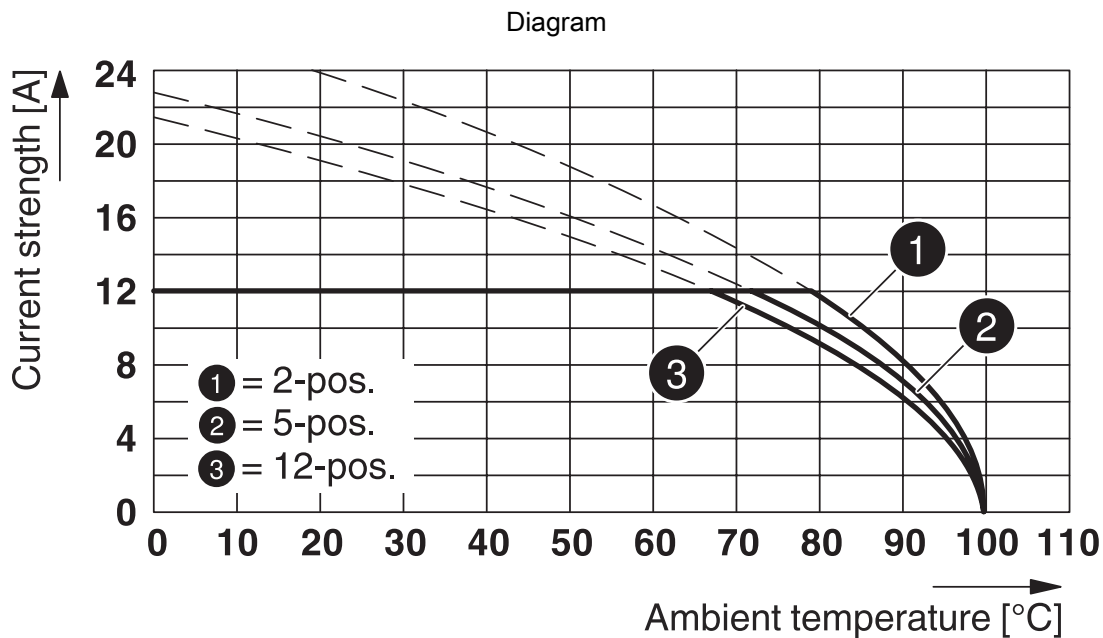

Type: MSTB 2,5/...-ST-5,08 with CCV 2,5/...-G-5,08 P26THR

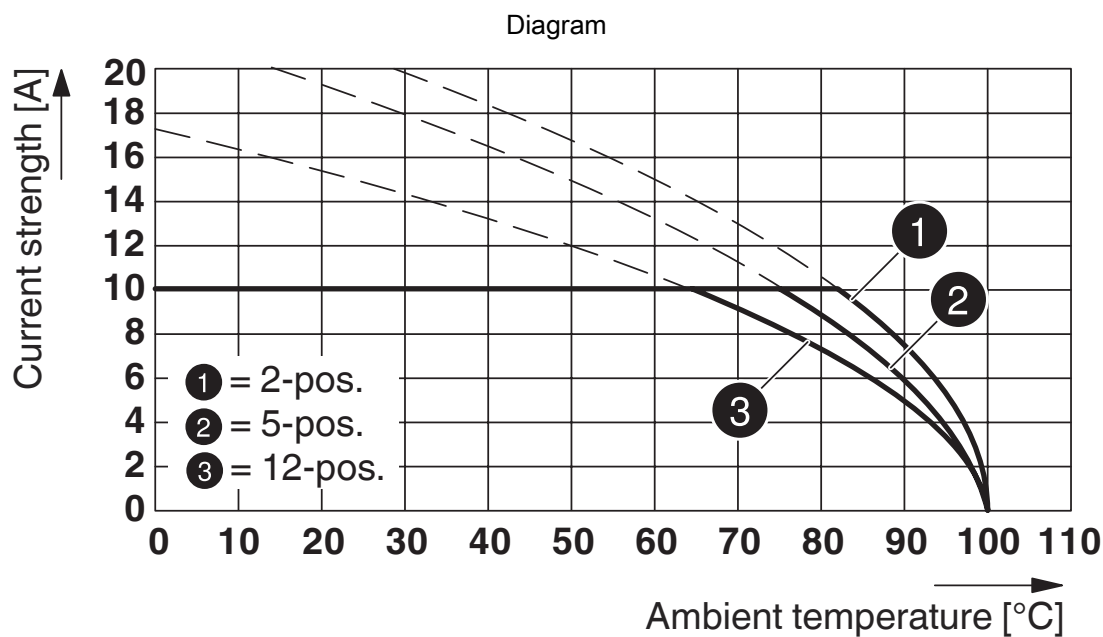

Type: MSTB 2,5/...-ST-5,08 with MDSTBW 2,5/...-G-5,08

# MSTB 2,5/ 3-ST-5,08 - PCB connector



1757022

<https://www.phoenixcontact.com/us/products/1757022>

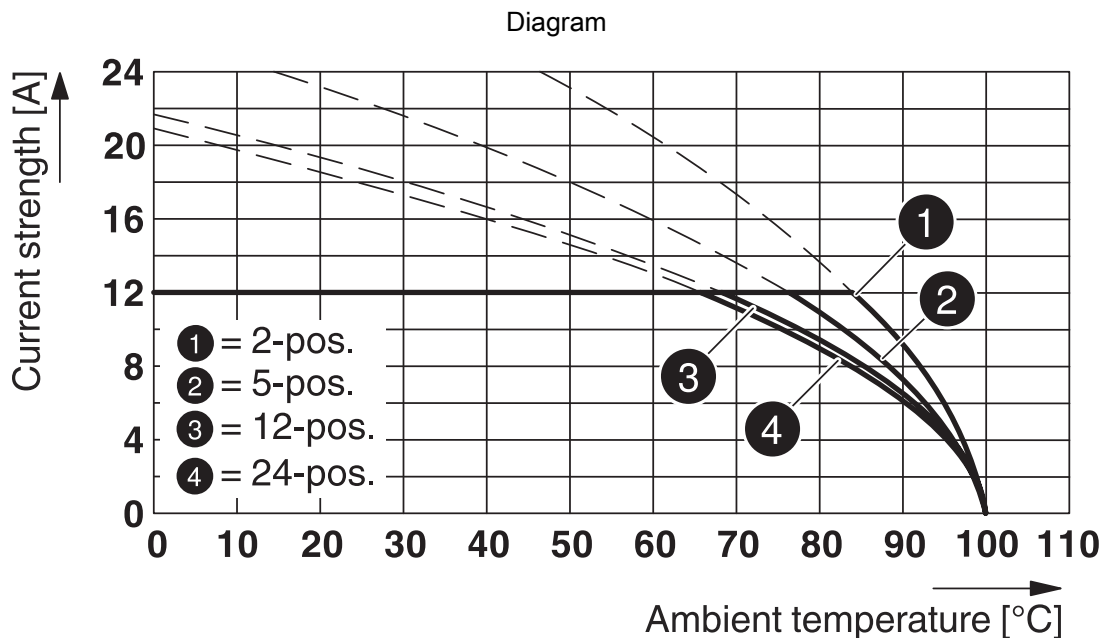

Type: MSTB 2,5/...-ST-5,08 with CCVA 2,5/...-G-5,08 P26THR

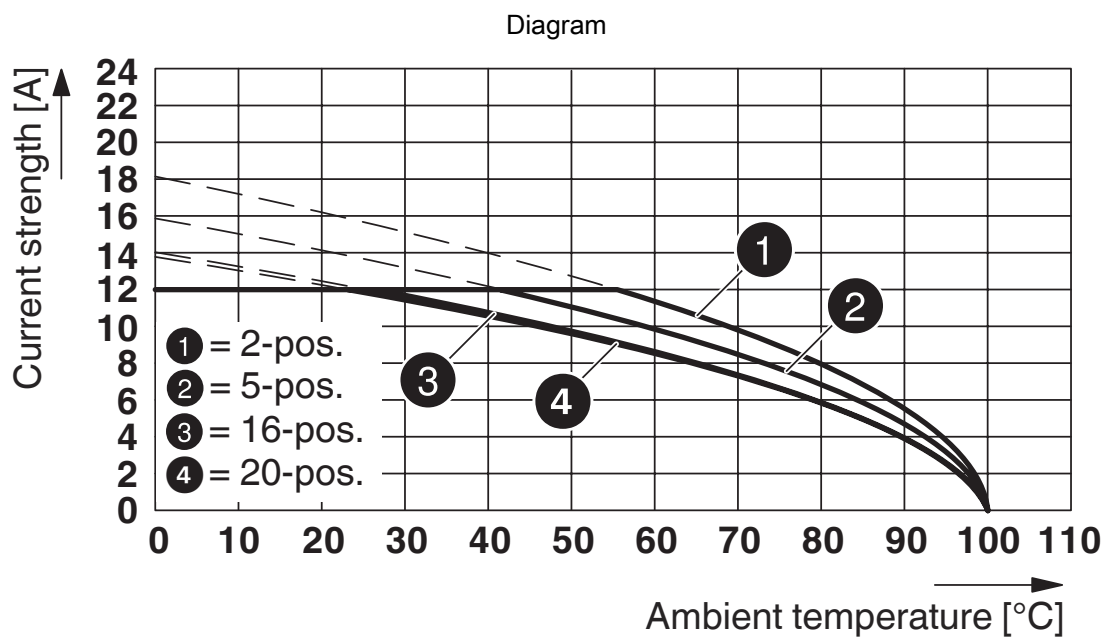

Type: MSTB 2,5/...-ST-5,08 with MSTBV 2,5/...-G-5,08

# MSTB 2,5/ 3-ST-5,08 - PCB connector



1757022

<https://www.phoenixcontact.com/us/products/1757022>

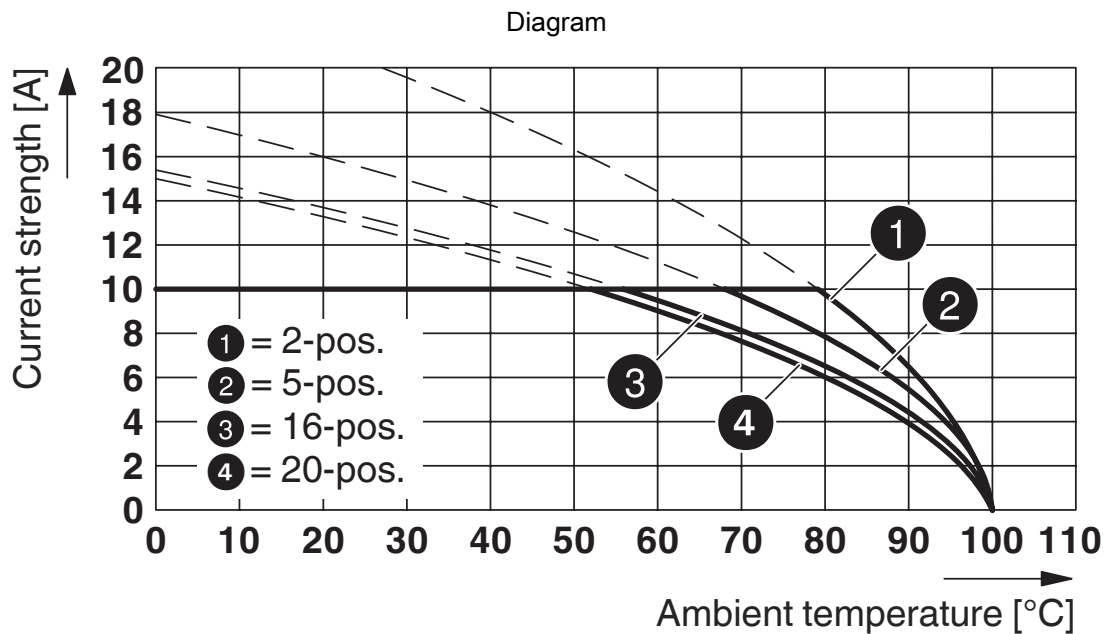

Type: MSTB 2,5/...-ST-5,08 with MDSTB 2,5/...-G1-5,08

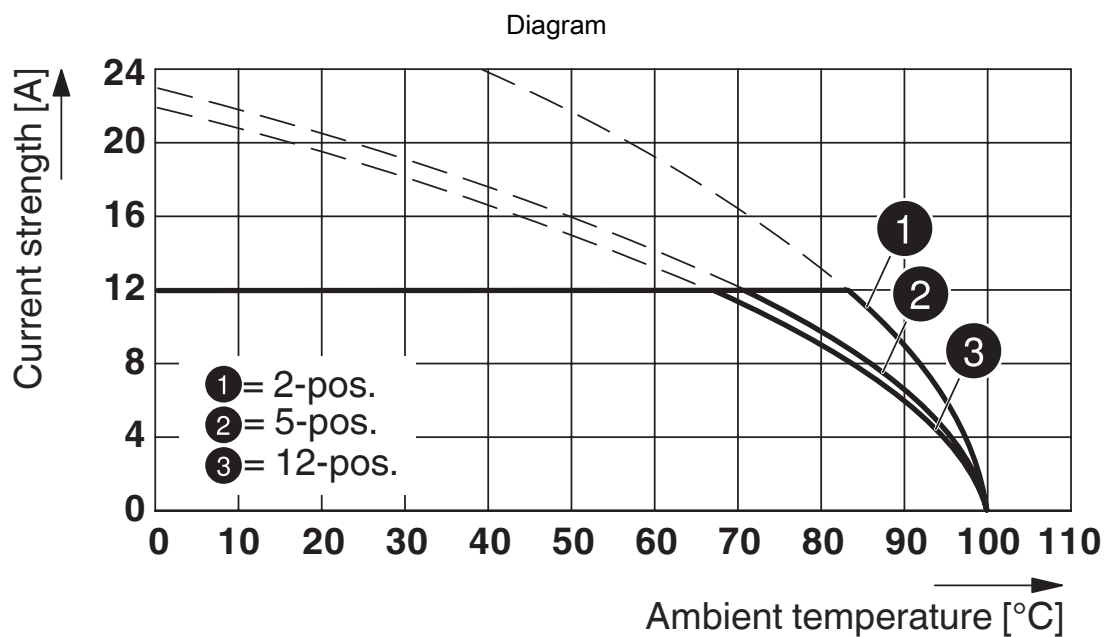

Type: MSTB 2,5/...-ST-5,08 with CC 2,5/...-G-5,08 P26THR



# MSTB 2,5/ 3-ST-5,08 - PCB connector



1757022

<https://www.phoenixcontact.com/us/products/1757022>

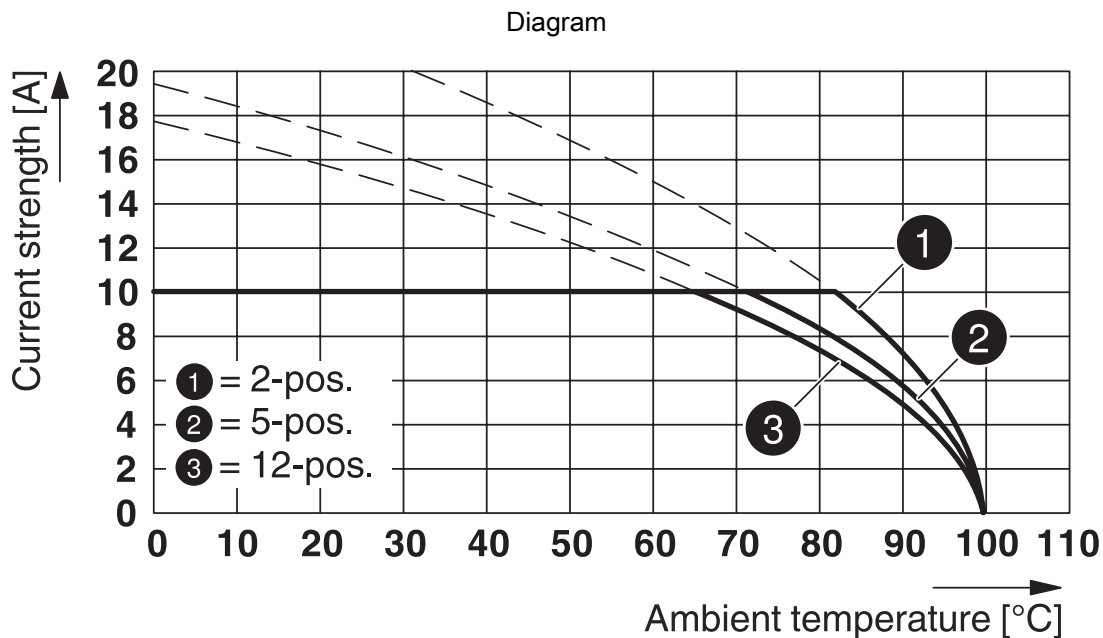

Type: MSTB 2,5/...-ST-5,08 with MDSTBA 2,5/...-G-5,08

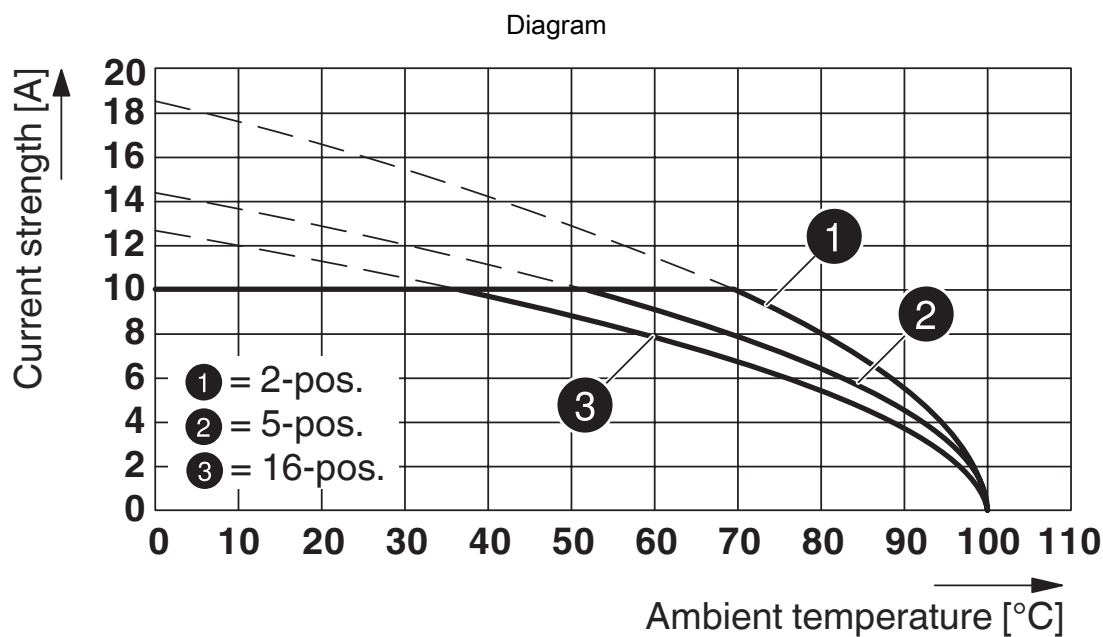

Type: MSTB 2,5/...-ST-5,08 with MDSTBVA 2,5/...-G-5,08

# MSTB 2,5/ 3-ST-5,08 - PCB connector



1757022

<https://www.phoenixcontact.com/us/products/1757022>

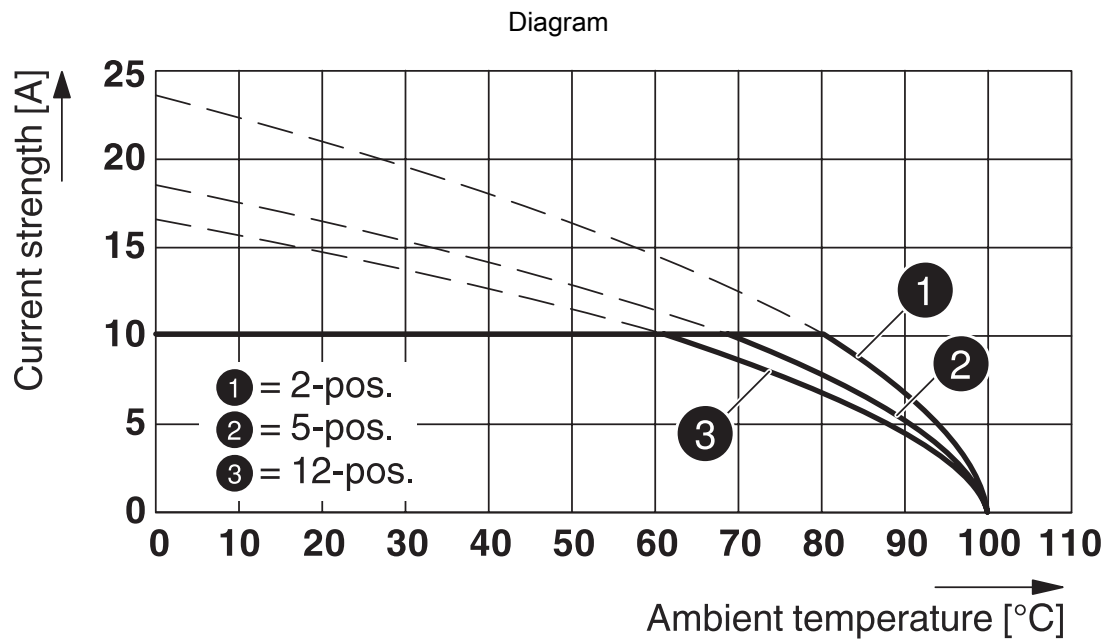

Type: MSTB 2,5/...-ST-5,08 with MDSTB 2,5/...-G-5,08

# MSTB 2,5/ 3-ST-5,08 - PCB connector





1757022

<https://www.phoenixcontact.com/us/products/1757022>

## Approvals

To download certificates, visit the product detail page: <https://www.phoenixcontact.com/us/products/1757022>

 <b>cULus Recognized</b> Approval ID: E60425-19931011				
	Nominal voltage $U_N$	Nominal current $I_N$	Cross section AWG	Cross section $\text{mm}^2$
Use group B	300 V	15 A	30 - 12	-
Use group D	300 V	10 A	30 - 12	-

 <b>VDE Zeichengenehmigung</b> Approval ID: 40050694				
	Nominal voltage $U_N$	Nominal current $I_N$	Cross section AWG	Cross section $\text{mm}^2$
	250 V	12 A	-	0.2 - 2.5

# MSTB 2,5/ 3-ST-5,08 - PCB connector



1757022

<https://www.phoenixcontact.com/us/products/1757022>

## Classifications

### ECLASS

ECLASS-11.0	27460202
ECLASS-12.0	27460202
ECLASS-13.0	27460202

### ETIM

ETIM 9.0	EC002638
----------	----------

### UNSPSC

UNSPSC 21.0	39121400
-------------	----------

# MSTB 2,5/ 3-ST-5,08 - PCB connector



1757022

<https://www.phoenixcontact.com/us/products/1757022>

## Environmental product compliance

### EU RoHS

Fulfills EU RoHS substance requirements	Yes, No exemptions
---	--------------------

### China RoHS

Environment friendly use period (EFUP)	EFUP-E
	No hazardous substances above the limits

### EU REACH SVHC

REACH candidate substance (CAS No.)	No substance above 0.1 wt%
-------------------------------------	----------------------------

### EF3.0 Climate Change

CO2e kg	0.05 kg CO2e
---------	--------------

# MSTB 2,5/ 3-ST-5,08 - PCB connector

1757022

<https://www.phoenixcontact.com/us/products/1757022>

## Accessories

 Note: Applying some accessories below might limit this product.

### EBP 2- 5 - Insertion bridge

1733169

<https://www.phoenixcontact.com/us/products/1733169>

Insertion bridge for connectors with 5.0 mm or 5.08 mm pitch



 Max. current carrying capacity: 12 A

---

### EBP 3- 5 - Insertion bridge

1733172

<https://www.phoenixcontact.com/us/products/1733172>

Insertion bridge for connectors with 5.0 mm or 5.08 mm pitch



 Max. current carrying capacity: 12 A

# MSTB 2,5/ 3-ST-5,08 - PCB connector

1757022

<https://www.phoenixcontact.com/us/products/1757022>



## SZS 0,6X3,5 - Screwdriver

1205053

<https://www.phoenixcontact.com/us/products/1205053>



Actuation tool, for ST terminal blocks, insulated, also suitable for use as a bladed screwdriver, size: 0.6 x 3.5 x 100 mm, 2-component grip, with non-slip grip

---

## KGG-MSTB 2,5/ 3 - Cable housing

1803947

<https://www.phoenixcontact.com/us/products/1803947>



Cable housing, color: green, product range: KGG-MSTB 2,5, width: 19 mm

# MSTB 2,5/ 3-ST-5,08 - PCB connector

1757022

<https://www.phoenixcontact.com/us/products/1757022>

## CP-MSTB - Coding profile

1734634

<https://www.phoenixcontact.com/us/products/1734634>

Coding profile, is inserted into the slot on the plug or inverted header, red insulating material



---

## SK 5,08/3,8:FORTL.ZAHLEN - Marker card

0804293

<https://www.phoenixcontact.com/us/products/0804293>

Marker card, white, labeled, horizontal: consecutive numbers 1 ... 10, 11 ... 20, etc. up to 91 ... (99)100, mounting type: adhesive, for terminal block width: 5.08 mm, lettering field size: 5.08 x 3.8 mm





# MSTB 2,5/ 3-ST-5,08 - PCB connector

1757022

<https://www.phoenixcontact.com/us/products/1757022>

## MSTBW 2,5/ 3-G-5,08 - PCB header

1735879

<https://www.phoenixcontact.com/us/products/1735879>

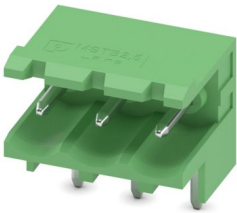

PCB headers, nominal cross section: 2.5 mm<sup>2</sup>, color: green, nominal current: 12 A, rated voltage (III/2): 320 V, contact surface: Tin, contact connection type: Pin, number of potentials: 3, number of rows: 1, number of positions: 3, number of connections: 3, product range: MSTBW 2,5/...-G, pitch: 5.08 mm, mounting: Wave soldering, pin layout: Linear pinning, solder pin [P]: 3.5 mm, number of solder pins per potential: 1, plug-in system: COMBICON MSTB 2,5, Pin connector pattern alignment: Standard, locking: without, mounting: without, type of packaging: packed in cardboard

## MDSTBV 2,5/ 3-G1-5,08 - PCB header

1736742

<https://www.phoenixcontact.com/us/products/1736742>

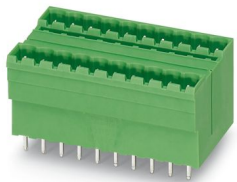

PCB headers, nominal cross section: 2.5 mm<sup>2</sup>, color: green, nominal current: 10 A, rated voltage (III/2): 320 V, contact surface: Tin, contact connection type: Pin, number of potentials: 6, number of rows: 2, number of positions: 3, number of connections: 6, product range: MDSTBV 2,5/...-G1, pitch: 5.08 mm, mounting: Wave soldering, pin layout: Linear pinning, solder pin [P]: 3.9 mm, number of solder pins per potential: 1, plug-in system: COMBICON MSTB 2,5, Pin connector pattern alignment: Standard, locking: without, mounting: without, type of packaging: packed in cardboard, In combination with MVSTB or FKCV plug components, both an MVSTBW (or FKCVW) and an MVSTBR plug (or FKCVR) must be used. Combination with TMSTBP plug components is not possible!

# MSTB 2,5/ 3-ST-5,08 - PCB connector

1757022

<https://www.phoenixcontact.com/us/products/1757022>

## MSTBV 2,5/ 3-G-5,08 - PCB header

1758021

<https://www.phoenixcontact.com/us/products/1758021>

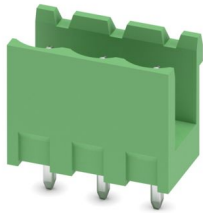

PCB headers, nominal cross section: 2.5 mm<sup>2</sup>, color: green, nominal current: 12 A, rated voltage (III/2): 320 V, contact surface: Tin, contact connection type: Pin, number of potentials: 3, number of rows: 1, number of positions: 3, number of connections: 3, product range: MSTBV 2,5/..-G, pitch: 5.08 mm, mounting: Wave soldering, pin layout: Linear pinning, solder pin [P]: 3.9 mm, number of solder pins per potential: 1, plug-in system: COMBICON MSTB 2,5, Pin connector pattern alignment: Standard, locking: without, mounting: without, type of packaging: packed in cardboard

## MSTB 2,5/ 3-G-5,08 - PCB header

1759020

<https://www.phoenixcontact.com/us/products/1759020>

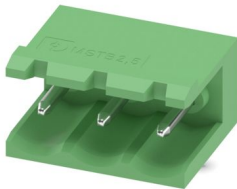

PCB headers, nominal cross section: 2.5 mm<sup>2</sup>, color: green, nominal current: 12 A, rated voltage (III/2): 320 V, contact surface: Tin, contact connection type: Pin, number of potentials: 3, number of rows: 1, number of positions: 3, number of connections: 3, product range: MSTB 2,5/..-G, pitch: 5.08 mm, mounting: Wave soldering, pin layout: Linear pinning, solder pin [P]: 3.23 mm, number of solder pins per potential: 1, plug-in system: COMBICON MSTB 2,5, Pin connector pattern alignment: Standard, locking: without, mounting: without, type of packaging: packed in cardboard

# MSTB 2,5/ 3-ST-5,08 - PCB connector

1757022

<https://www.phoenixcontact.com/us/products/1757022>

## MDSTB 2,5/ 3-G-5,08 - PCB header

1762075

<https://www.phoenixcontact.com/us/products/1762075>

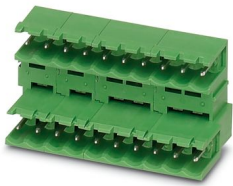

PCB headers, nominal cross section: 2.5 mm<sup>2</sup>, color: green, nominal current: 10 A, rated voltage (III/2): 320 V, contact surface: Tin, contact connection type: Pin, number of potentials: 6, number of rows: 2, number of positions: 3, number of connections: 6, product range: MDSTB 2,5/..-G, pitch: 5.08 mm, mounting: Wave soldering, pin layout: Linear pinning, solder pin [P]: 3.23 mm, number of solder pins per potential: 1, plug-in system: COMBICON MSTB 2,5, Pin connector pattern alignment: Standard, locking: without, mounting: without, type of packaging: packed in cardboard, Can be aligned! Mounting flange: Item No. 1736771, 1736768. In combination with MVSTB or FKCV plugs, both an MVSTBW (or FKCVW) and an MVSTBR plug (or FKCVR) must be used. Combination with TMSTBP plugs is not possible!

## MDSTB 2,5/ 3-G1-5,08 - PCB header

1762376

<https://www.phoenixcontact.com/us/products/1762376>

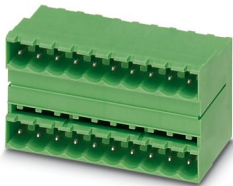

PCB headers, nominal cross section: 2.5 mm<sup>2</sup>, color: green, nominal current: 10 A, rated voltage (III/2): 320 V, contact surface: Tin, contact connection type: Pin, number of potentials: 6, number of rows: 2, number of positions: 3, number of connections: 6, product range: MDSTB 2,5/..-G1, pitch: 5.08 mm, mounting: Wave soldering, pin layout: Linear pinning, solder pin [P]: 3.3 mm, number of solder pins per potential: 1, plug-in system: COMBICON MSTB 2,5, Pin connector pattern alignment: Standard, locking: without, mounting: without, type of packaging: packed in cardboard, In combination with MVSTB or FKCV plug components, both an MVSTBW (or FKCVW) and an MVSTBR plug (or FKCVR) must be used. Combination with TMSTBP plug components is not possible!

# MSTB 2,5/ 3-ST-5,08 - PCB connector

1757022

<https://www.phoenixcontact.com/us/products/1757022>

## MDSTBV 2,5/ 3-G-5,08 - PCB header

1763087

<https://www.phoenixcontact.com/us/products/1763087>

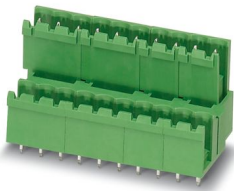

PCB headers, nominal cross section: 2.5 mm<sup>2</sup>, color: green, nominal current: 10 A, rated voltage (III/2): 320 V, contact surface: Tin, contact connection type: Pin, number of potentials: 6, number of rows: 2, number of positions: 3, number of connections: 6, product range: MDSTBV 2,5/..-G, pitch: 5.08 mm, mounting: Wave soldering, pin layout: Linear pinning, solder pin [P]: 3.9 mm, number of solder pins per potential: 1, plug-in system: COMBICON MSTB 2,5, Pin connector pattern alignment: Standard, locking: without, mounting: without, type of packaging: packed in cardboard, Can be aligned! Mounting flange: Item No. 1836477, 1836480. In combination with MVSTB or FKCV plug components, both an MVSTBW (or FKCVW) and an MVSTBR plug (or FKCVR) must be used. Combination with TMSTBP plug components is not possible!

## SMSTBA 2,5/ 3-G-5,08 - PCB header

1767384

<https://www.phoenixcontact.com/us/products/1767384>



PCB headers, nominal cross section: 2.5 mm<sup>2</sup>, color: green, nominal current: 12 A, rated voltage (III/2): 320 V, contact surface: Tin, contact connection type: Pin, number of potentials: 3, number of rows: 1, number of positions: 3, number of connections: 3, product range: SMSTBA 2,5/..-G, pitch: 5.08 mm, mounting: Wave soldering, pin layout: Linear pinning, solder pin [P]: 3.5 mm, number of solder pins per potential: 1, plug-in system: COMBICON MSTB 2,5, Pin connector pattern alignment: Standard, locking: without, mounting: without, type of packaging: packed in cardboard

# MSTB 2,5/ 3-ST-5,08 - PCB connector

1757022

<https://www.phoenixcontact.com/us/products/1757022>

## SMSTB 2,5/ 3-G-5,08 - PCB header

1769476

<https://www.phoenixcontact.com/us/products/1769476>



PCB headers, nominal cross section: 2.5 mm<sup>2</sup>, color: green, nominal current: 12 A, rated voltage (III/2): 320 V, contact surface: Tin, contact connection type: Pin, number of potentials: 3, number of rows: 1, number of positions: 3, number of connections: 3, product range: SMSTB 2,5/..-G, pitch: 5.08 mm, mounting: Wave soldering, pin layout: Linear pinning, solder pin [P]: 3.5 mm, number of solder pins per potential: 1, plug-in system: COMBICON MSTB 2,5, Pin connector pattern alignment: Standard, locking: without, mounting: without, type of packaging: packed in cardboard

## MDSTBA 2,5/ 3-G-5,08 - PCB header

1842076

<https://www.phoenixcontact.com/us/products/1842076>

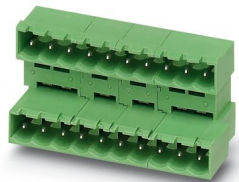

PCB headers, nominal cross section: 2.5 mm<sup>2</sup>, color: green, nominal current: 10 A, rated voltage (III/2): 320 V, contact surface: Tin, contact connection type: Pin, number of potentials: 6, number of rows: 2, number of positions: 3, number of connections: 6, product range: MDSTBA 2,5/..-G, pitch: 5.08 mm, mounting: Wave soldering, pin layout: Linear pinning, solder pin [P]: 3.23 mm, number of solder pins per potential: 1, plug-in system: COMBICON MSTB 2,5, Pin connector pattern alignment: Standard, locking: without, mounting: without, type of packaging: packed in cardboard, The article can be aligned to create different nos. of positions! In combination with MVSTB or FKCV plug components, both an MVSTBW (or FKCVW) and an MVSTBR plug (or FKCVR) must be used. Combination with TMSTBP plug components is not possible!

# MSTB 2,5/ 3-ST-5,08 - PCB connector



1757022

<https://www.phoenixcontact.com/us/products/1757022>

## MDSTBVA 2,5/ 3-G-5,08 - PCB header

1845345

<https://www.phoenixcontact.com/us/products/1845345>

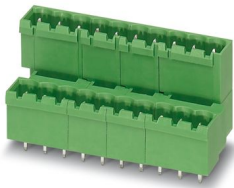

PCB headers, nominal cross section: 2.5 mm<sup>2</sup>, color: green, nominal current: 10 A, rated voltage (III/2): 320 V, contact surface: Tin, contact connection type: Pin, number of potentials: 6, number of rows: 2, number of positions: 3, number of connections: 6, product range: MDSTBVA 2,5/..-G, pitch: 5.08 mm, mounting: Wave soldering, pin layout: Linear pinning, solder pin [P]: 3.9 mm, number of solder pins per potential: 1, plug-in system: COMBICON MSTB 2,5, Pin connector pattern alignment: Standard, locking: without, mounting: without, type of packaging: packed in cardboard, The article can be aligned to create different nos. of positions! In combination with MVSTB or FKCV plug components, both an MVSTBW (or FKCVW) and an MVSTBR plug (or FKCVR) must be used. Combination with TMSTBP plug components is not possible!

## MSTBO 2,5/ 3-GR-5,08 - PCB header

1847110

<https://www.phoenixcontact.com/us/products/1847110>



PCB headers, nominal cross section: 2.5 mm<sup>2</sup>, color: green, nominal current: 8 A, rated voltage (III/2): 320 V, contact surface: Tin, contact connection type: Pin, number of potentials: 3, number of rows: 1, number of positions: 3, number of connections: 3, product range: MSTBO 2,5/..-GR, pitch: 5.08 mm, mounting: Wave soldering, pin layout: Linear pinning, solder pin [P]: 3.2 mm, number of solder pins per potential: 1, plug-in system: COMBICON MSTB 2,5, locking: without, mounting: without, type of packaging: packed in cardboard

# MSTB 2,5/ 3-ST-5,08 - PCB connector

1757022

<https://www.phoenixcontact.com/us/products/1757022>

## MSTBO 2,5/ 3-GL-5,08 - PCB header

1850440

<https://www.phoenixcontact.com/us/products/1850440>



PCB headers, nominal cross section: 2.5 mm<sup>2</sup>, color: green, nominal current: 8 A, rated voltage (III/2): 320 V, contact surface: Tin, contact connection type: Pin, number of potentials: 3, number of rows: 1, number of positions: 3, number of connections: 3, product range: MSTBO 2,5/..-GL, pitch: 5.08 mm, mounting: Wave soldering, pin layout: Linear pinning, solder pin [P]: 3.2 mm, number of solder pins per potential: 1, plug-in system: COMBICON MSTB 2,5, locking: without, mounting: without, type of packaging: packed in cardboard

---

## MDSTBA 2,5/ 3-GL-5,08 - PCB header

1874714

<https://www.phoenixcontact.com/us/products/1874714>

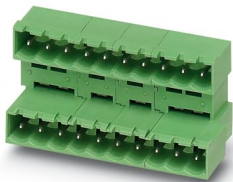

PCB headers, nominal cross section: 2.5 mm<sup>2</sup>, color: green, nominal current: 10 A, rated voltage (III/2): 320 V, contact surface: Tin, contact connection type: Pin, number of potentials: 6, number of rows: 2, number of positions: 3, number of connections: 6, product range: MDSTBA 2,5/..-G, pitch: 5.08 mm, mounting: Wave soldering, pin layout: Linear pinning, solder pin [P]: 3.23 mm, number of solder pins per potential: 1, plug-in system: COMBICON MSTB 2,5, Pin connector pattern alignment: Standard, locking: without, mounting: without, type of packaging: packed in cardboard, The article can be aligned to create different nos. of positions! In combination with MVSTB or FKCV plug components, both an MVSTBW (or FKCVW) and an MVSTBR plug (or FKCVR) must be used. Combination with TMSTBP plug components is not possible!

# MSTB 2,5/ 3-ST-5,08 - PCB connector

1757022

<https://www.phoenixcontact.com/us/products/1757022>

## MDSTBA 2,5/ 3-GR-5,08 - PCB header

1874727

<https://www.phoenixcontact.com/us/products/1874727>

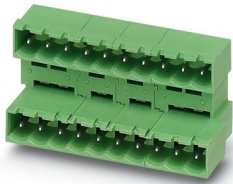

PCB headers, nominal cross section: 2.5 mm<sup>2</sup>, color: green, nominal current: 10 A, rated voltage (III/2): 320 V, contact surface: Tin, contact connection type: Pin, number of potentials: 6, number of rows: 2, number of positions: 3, number of connections: 6, product range: MDSTBA 2,5/..-G, pitch: 5.08 mm, mounting: Wave soldering, pin layout: Linear pinning, solder pin [P]: 3.23 mm, number of solder pins per potential: 1, plug-in system: COMBICON MSTB 2,5, Pin connector pattern alignment: Standard, locking: without, mounting: without, type of packaging: packed in cardboard, The article can be aligned to create different nos. of positions! In combination with MVSTB or FKCV plug components, both an MVSTBW (or FKCVW) and an MVSTBR plug (or FKCVR) must be used. Combination with TMSTBP plug components is not possible!

## MDSTBVA 2,5/ 3-GL-5,08 - PCB header

1874756

<https://www.phoenixcontact.com/us/products/1874756>

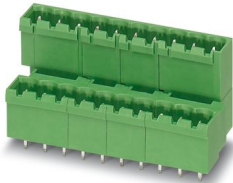

PCB headers, nominal cross section: 2.5 mm<sup>2</sup>, color: green, nominal current: 10 A, rated voltage (III/2): 320 V, contact surface: Tin, contact connection type: Pin, number of potentials: 6, number of rows: 2, number of positions: 3, number of connections: 6, product range: MDSTBVA 2,5/..-G, pitch: 5.08 mm, mounting: Wave soldering, pin layout: Linear pinning, solder pin [P]: 3.9 mm, number of solder pins per potential: 1, plug-in system: COMBICON MSTB 2,5, Pin connector pattern alignment: Standard, locking: without, mounting: without, type of packaging: packed in cardboard, The article can be aligned to create different nos. of positions! In combination with MVSTB or FKCV plug components, both an MVSTBW (or FKCVW) and an MVSTBR plug (or FKCVR) must be used. Combination with TMSTBP plug components is not possible!



# MSTB 2,5/ 3-ST-5,08 - PCB connector

1757022

<https://www.phoenixcontact.com/us/products/1757022>

## MDSTBVA 2,5/ 3-GR-5,08 - PCB header

1874769

<https://www.phoenixcontact.com/us/products/1874769>

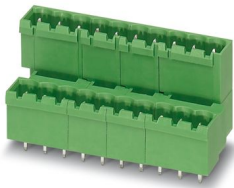

PCB headers, nominal cross section: 2.5 mm<sup>2</sup>, color: green, nominal current: 10 A, rated voltage (III/2): 320 V, contact surface: Tin, contact connection type: Pin, number of potentials: 6, number of rows: 2, number of positions: 3, number of connections: 6, product range: MDSTBVA 2,5/..-G, pitch: 5.08 mm, mounting: Wave soldering, pin layout: Linear pinning, solder pin [P]: 3.9 mm, number of solder pins per potential: 1, plug-in system: COMBICON MSTB 2,5, Pin connector pattern alignment: Standard, locking: without, mounting: without, type of packaging: packed in cardboard, The article can be aligned to create different nos. of positions! In combination with MVSTB or FKCV plug components, both an MVSTBW (or FKCVW) and an MVSTBR plug (or FKCVR) must be used. Combination with TMSTBP plug components is not possible!

---

## DFK-MSTBA 2,5/ 3-G-5,08 - Feed-through header

1898842

<https://www.phoenixcontact.com/us/products/1898842>



Feed-through header, nominal cross section: 2.5 mm<sup>2</sup>, color: green, nominal current: 12 A, rated voltage (III/2): 320 V, contact surface: Tin, contact connection type: Pin, number of potentials: 3, number of rows: 1, number of positions: 3, number of connections: 3, product range: DFK-MSTBA 2,5/..-G, pitch: 5.08 mm, mounting: Wave soldering, pin layout: Linear pinning, solder pin [P]: 3.23 mm, number of solder pins per potential: 1, plug-in system: COMBICON MSTB 2,5, Pin connector pattern alignment: Standard, locking: without, mounting: without, type of packaging: packed in cardboard

# MSTB 2,5/ 3-ST-5,08 - PCB connector

1757022

<https://www.phoenixcontact.com/us/products/1757022>

## DFK-MSTBVA 2,5/ 3-G-5,08 - Feed-through header

1899142

<https://www.phoenixcontact.com/us/products/1899142>

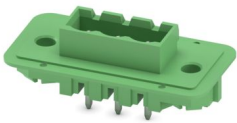

Feed-through header, nominal cross section: 2.5 mm<sup>2</sup>, color: green, nominal current: 12 A, rated voltage (III/2): 320 V, contact surface: Tin, contact connection type: Pin, number of potentials: 3, number of rows: 1, number of positions: 3, number of connections: 3, product range: DFK-MSTBVA 2,5/..-G, pitch: 5.08 mm, mounting: Wave soldering, pin layout: Linear pinning, solder pin [P]: 3.9 mm, number of solder pins per potential: 1, plug-in system: COMBICON MSTB 2,5, Pin connector pattern alignment: Standard, locking: without, mounting: without, type of packaging: packed in cardboard

---

## CC 2,5/ 3-G-5,08 P26THR - PCB header

1954391

<https://www.phoenixcontact.com/us/products/1954391>



PCB headers, nominal cross section: 2.5 mm<sup>2</sup>, color: black, nominal current: 12 A, rated voltage (III/2): 320 V, contact surface: Tin, contact connection type: Pin, number of potentials: 3, number of rows: 1, number of positions: 3, number of connections: 3, product range: CC 2,5/..-G, pitch: 5.08 mm, mounting: THR soldering / wave soldering, pin layout: Linear pinning, solder pin [P]: 2.6 mm, number of solder pins per potential: 1, plug-in system: COMBICON MSTB 2,5, Pin connector pattern alignment: Standard, locking: without, mounting: without, type of packaging: packed in cardboard, For user information and design recommendations for through-hole reflow technology, go to: Downloads

# MSTB 2,5/ 3-ST-5,08 - PCB connector

1757022

<https://www.phoenixcontact.com/us/products/1757022>

## CC 2,5/ 3-G-5,08 P26THRR32 - PCB header

1954595

<https://www.phoenixcontact.com/us/products/1954595>



PCB headers, nominal cross section: 2.5 mm<sup>2</sup>, color: black, nominal current: 12 A, rated voltage (III/2): 320 V, contact surface: Tin, contact connection type: Pin, number of potentials: 3, number of rows: 1, number of positions: 3, number of connections: 3, product range: CC 2,5/..-G, pitch: 5.08 mm, mounting: THR soldering / wave soldering, pin layout: Linear pinning, solder pin [P]: 2.6 mm, number of solder pins per potential: 1, plug-in system: COMBICON MSTB 2,5, Pin connector pattern alignment: Standard, locking: without, mounting: without, type of packaging: 32 mm wide tape, For user information and design recommendations for through-hole reflow technology, go to: Downloads

## CCA 2,5/ 3-G-5,08 P26THR - PCB header

1954922

<https://www.phoenixcontact.com/us/products/1954922>



PCB headers, nominal cross section: 2.5 mm<sup>2</sup>, color: black, nominal current: 12 A, rated voltage (III/2): 320 V, contact surface: Tin, contact connection type: Pin, number of potentials: 3, number of rows: 1, number of positions: 3, number of connections: 3, product range: CCA 2,5/..-G, pitch: 5.08 mm, connection method: Plug-in connection, mounting: THR soldering / wave soldering, pin layout: Linear pinning, solder pin [P]: 2.6 mm, number of solder pins per potential: 1, plug-in system: COMBICON MSTB 2,5, Pin connector pattern alignment: Standard, locking: without, mounting: without, type of packaging: packed in cardboard, For user information and design recommendations for through-hole reflow technology, go to: Downloads

# MSTB 2,5/ 3-ST-5,08 - PCB connector

1757022

<https://www.phoenixcontact.com/us/products/1757022>

## CCA 2,5/ 3-G-5,08 P26THRR32 - PCB header

1955044

<https://www.phoenixcontact.com/us/products/1955044>



PCB headers, nominal cross section: 2.5 mm<sup>2</sup>, color: black, nominal current: 12 A, rated voltage (III/2): 320 V, contact surface: Tin, contact connection type: Pin, number of potentials: 3, number of rows: 1, number of positions: 3, number of connections: 3, product range: CCA 2,5/..-G, pitch: 5.08 mm, connection method: Plug-in connection, mounting: THR soldering / wave soldering, pin layout: Linear pinning, solder pin [P]: 2.6 mm, number of solder pins per potential: 1, plug-in system: COMBICON MSTB 2,5, Pin connector pattern alignment: Standard, locking: without, mounting: without, type of packaging: 32 mm wide tape, For user information and design recommendations for through-hole reflow technology, go to: Downloads

## CCV 2,5/ 3-G-5,08 P26THR - PCB header

1955390

<https://www.phoenixcontact.com/us/products/1955390>

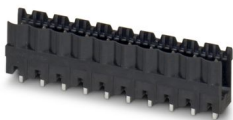

PCB headers, nominal cross section: 2.5 mm<sup>2</sup>, color: black, nominal current: 12 A, rated voltage (III/2): 320 V, contact surface: Tin, contact connection type: Pin, number of potentials: 3, number of rows: 1, number of positions: 3, number of connections: 3, product range: CCV 2,5/..-G, pitch: 5.08 mm, mounting: THR soldering / wave soldering, pin layout: Linear pinning, solder pin [P]: 2.6 mm, number of solder pins per potential: 1, plug-in system: COMBICON MSTB 2,5, Pin connector pattern alignment: Standard, locking: without, mounting: without, type of packaging: packed in cardboard, For user information and design recommendations for through-hole reflow technology, go to: Downloads

# MSTB 2,5/ 3-ST-5,08 - PCB connector

1757022

<https://www.phoenixcontact.com/us/products/1757022>

## CCV 2,5/ 3-G-5,08 P26THRR32 - PCB header

1955536

<https://www.phoenixcontact.com/us/products/1955536>

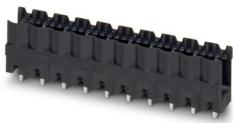

PCB headers, nominal cross section: 2.5 mm<sup>2</sup>, color: black, nominal current: 12 A, rated voltage (III/2): 320 V, contact surface: Tin, contact connection type: Pin, number of potentials: 3, number of rows: 1, number of positions: 3, number of connections: 3, product range: CCV 2,5/...-G, pitch: 5.08 mm, mounting: THR soldering / wave soldering, pin layout: Linear pinning, solder pin [P]: 2.6 mm, number of solder pins per potential: 1, plug-in system: COMBICON MSTB 2,5, Pin connector pattern alignment: Standard, locking: without, mounting: without, type of packaging: 32 mm wide tape, For user information and design recommendations for through-hole reflow technology, go to: Downloads

## CCVA 2,5/ 3-G-5,08 P26THR - PCB header

1955866

<https://www.phoenixcontact.com/us/products/1955866>

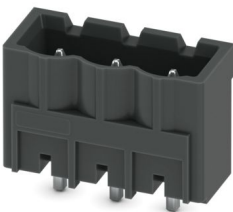

PCB headers, nominal cross section: 2.5 mm<sup>2</sup>, color: black, nominal current: 12 A, rated voltage (III/2): 320 V, contact surface: Tin, contact connection type: Pin, number of potentials: 3, number of rows: 1, number of positions: 3, number of connections: 3, product range: CCVA 2,5/...-G, pitch: 5.08 mm, mounting: THR soldering / wave soldering, pin layout: Linear pinning, solder pin [P]: 2.6 mm, number of solder pins per potential: 1, plug-in system: COMBICON MSTB 2,5, Pin connector pattern alignment: Standard, locking: without, mounting: without, type of packaging: packed in cardboard, For user information and design recommendations for through-hole reflow technology, go to: Downloads

# MSTB 2,5/ 3-ST-5,08 - PCB connector

1757022

<https://www.phoenixcontact.com/us/products/1757022>



## CCVA 2,5/ 3-G-5,08 P26THRR32 - PCB header

1955976

<https://www.phoenixcontact.com/us/products/1955976>



PCB headers, nominal cross section: 2.5 mm<sup>2</sup>, color: black, nominal current: 12 A, rated voltage (III/2): 320 V, contact surface: Tin, contact connection type: Pin, number of potentials: 3, number of rows: 1, number of positions: 3, number of connections: 3, product range: CCVA 2,5/...-G, pitch: 5.08 mm, mounting: THR soldering / wave soldering, pin layout: Linear pinning, solder pin [P]: 2.6 mm, number of solder pins per potential: 1, plug-in system: COMBICON MSTB 2,5, Pin connector pattern alignment: Standard, locking: without, mounting: without, type of packaging: 32 mm wide tape, For user information and design recommendations for through-hole reflow technology, go to: Downloads

---

Phoenix Contact 2024 © - all rights reserved

<https://www.phoenixcontact.com>

Phoenix Contact USA  
586 Fulling Mill Road  
Middletown, PA 17057, United States  
(+717) 944-1300  
[info@phoenixcon.com](mailto:info@phoenixcon.com)