

SKiiP 38AC126V2

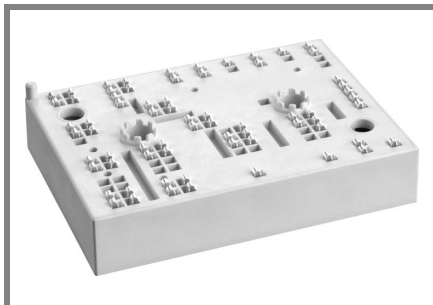

MiniSKiiP® 3

3-phase bridge inverter

SKiiP 38AC126V2

Features

- Fast Trench IGBTs
- Robust and soft freewheeling diodes in CAL technology
- Highly reliable spring contacts for electrical connections
- UL recognised file no. E63532

Typical Applications

- Inverter up to 39 kVA
- Typical motor power 22 kW

Remarks

- V_{CEsat} , V_F = chip level value

Absolute Maximum Ratings		$T_s = 25\text{ °C}$, unless otherwise specified	
Symbol	Conditions	Values	Units
IGBT - Inverter			
V_{CES}	$T_s = 25\text{ (70) °C}$ $t_p \leq 1\text{ ms}$	1200	V
I_C		118 (88)	A
I_{CRM}		210	A
V_{GES}		± 20	V
T_j		- 40 ... + 150	°C
Diode - Inverter			
I_F	$T_s = 25\text{ (70) °C}$ $t_p \leq 1\text{ ms}$	118 (88)	A
I_{FRM}		210	A
T_j		- 40 ... + 150	°C
I_{tRMS}	per power terminal (20 A / spring)	160	A
T_{stg}	$T_{op} \leq T_{stg}$	- 40 ... + 125	°C
V_{isol}	AC, 1 min.	2500	V

Characteristics		$T_s = 25\text{ °C}$, unless otherwise specified			
Symbol	Conditions	min.	typ.	max.	Units
IGBT - Inverter					
V_{CEsat}	$I_{Cnom} = 105\text{ A}$, $T_j = 25\text{ (125) °C}$		1,7 (2)	2,1 (2,4)	V
$V_{GE(th)}$	$V_{GE} = V_{CE}$, $I_C = 3\text{ mA}$	5	5,8	6,5	V
$V_{CE(TO)}$	$T_j = 25\text{ (125) °C}$		1 (0,9)	1,2 (1,1)	V
r_T	$T_j = 25\text{ (125) °C}$		6,7 (10)	8,6 (12)	mΩ
C_{ies}	$V_{CE} = 25\text{ V}$, $V_{GE} = 0\text{ V}$, $f = 1\text{ MHz}$		8,4		nF
C_{oes}	$V_{CE} = 25\text{ V}$, $V_{GE} = 0\text{ V}$, $f = 1\text{ MHz}$		1,5		nF
C_{res}	$V_{CE} = 25\text{ V}$, $V_{GE} = 0\text{ V}$, $f = 1\text{ MHz}$		1,1		nF
$R_{th(j-s)}$	per IGBT		0,4		K/W
$t_{d(on)}$	under following conditions		75		ns
t_r	$V_{CC} = 600\text{ V}$, $V_{GE} = \pm 15\text{ V}$		35		ns
$t_{d(off)}$	$I_{Cnom} = 105\text{ A}$, $T_j = 125\text{ °C}$		465		ns
t_f	$R_{Gon} = R_{Goff} = 5\text{ Ω}$		90		ns
E_{on}	inductive load		13,1		mJ
E_{off}			13		mJ
Diode - Inverter					
$V_F = V_{EC}$	$I_{Fnom} = 105\text{ A}$, $T_j = 25\text{ (125) °C}$		1,6 (1,6)	1,8 (1,8)	V
$V_{(TO)}$	$T_j = 25\text{ (125) °C}$		1 (0,8)	1,1 (0,9)	V
r_T	$T_j = 25\text{ (125) °C}$		5,7 (7,6)	6,7 (8,6)	mΩ
$R_{th(j-s)}$	per diode		0,55		K/W
I_{RRM}	under following conditions		175		A
Q_{rr}	$I_{Fnom} = 105\text{ A}$, $V_R = 600\text{ V}$		26		μC
E_{rr}	$V_{GE} = 0\text{ V}$, $T_j = 125\text{ °C}$		11,2		mJ
	$di_F/dt = 4000\text{ A/μs}$				
Temperature Sensor					
R_{ts}	3 %, $T_r = 25\text{ (100) °C}$		1000(1670)		Ω
Mechanical Data					
m			95		g
M_s	Mounting torque	2		2,5	Nm

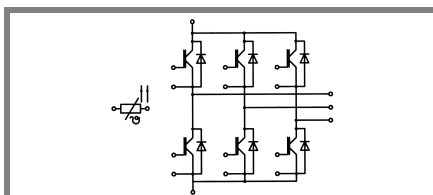

AC

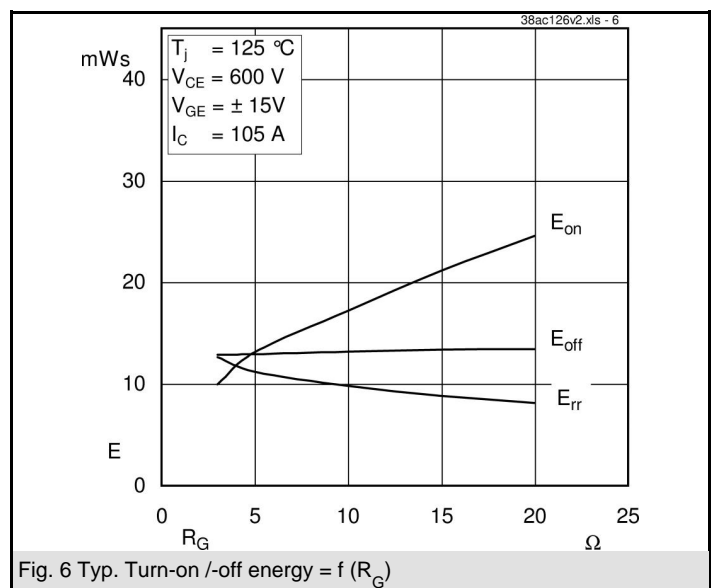
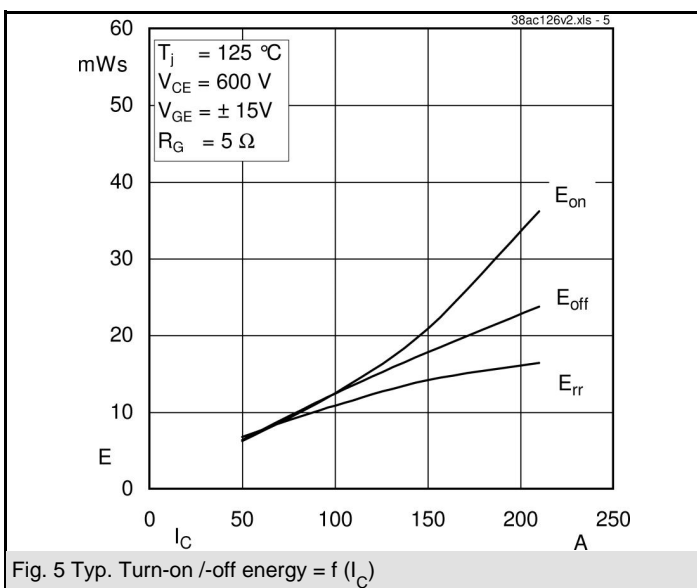
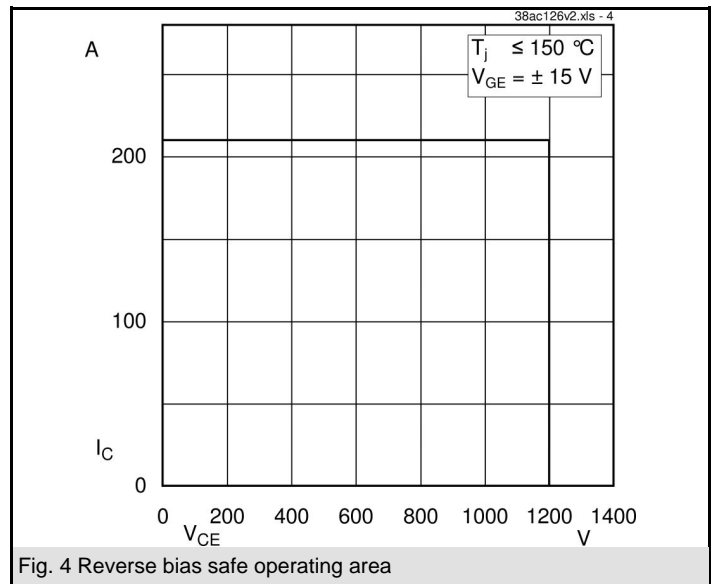
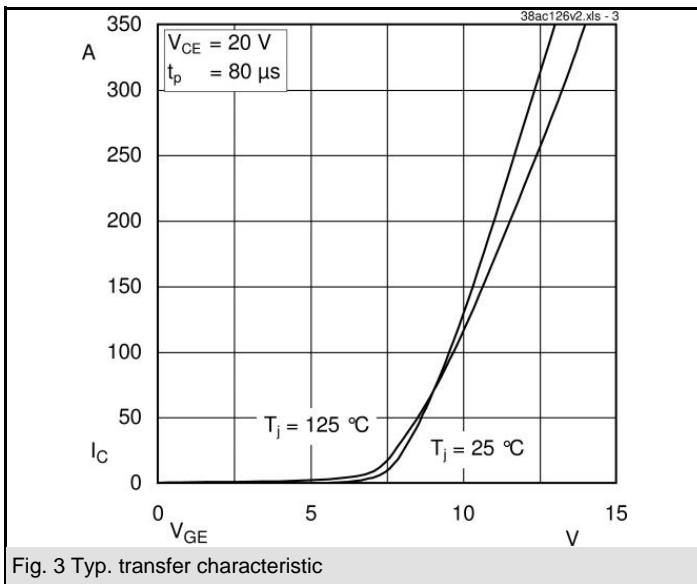
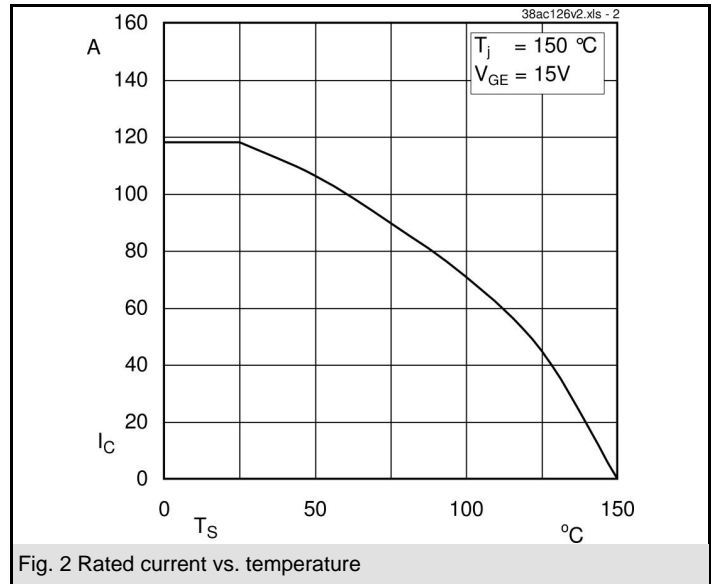
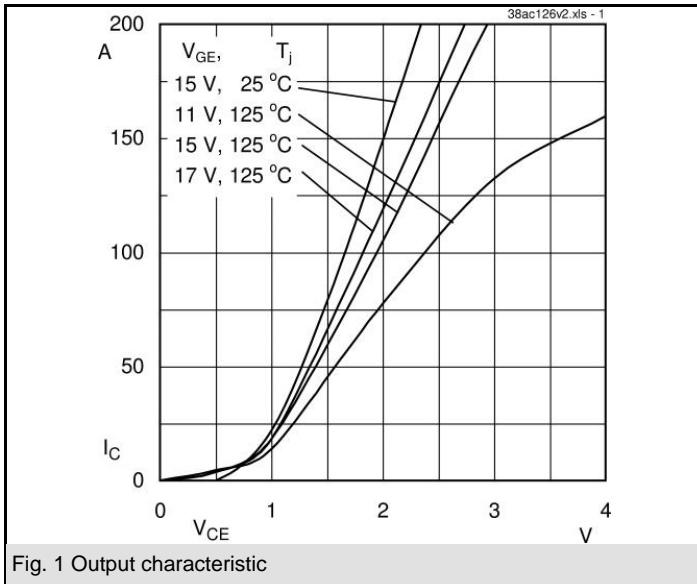

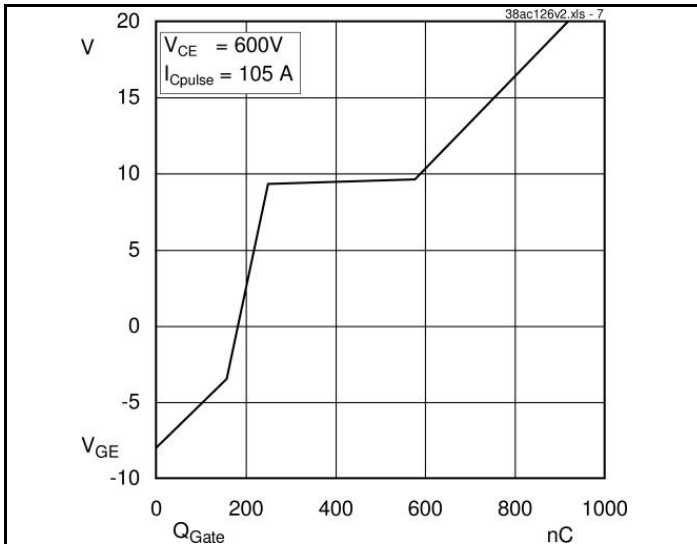

Fig. 7 Typ. gate charge characteristic

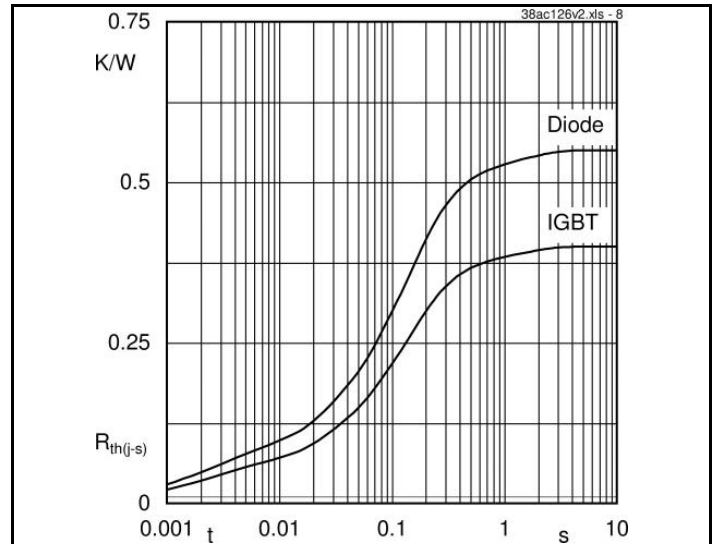

Fig. 8 Typ. thermal impedance

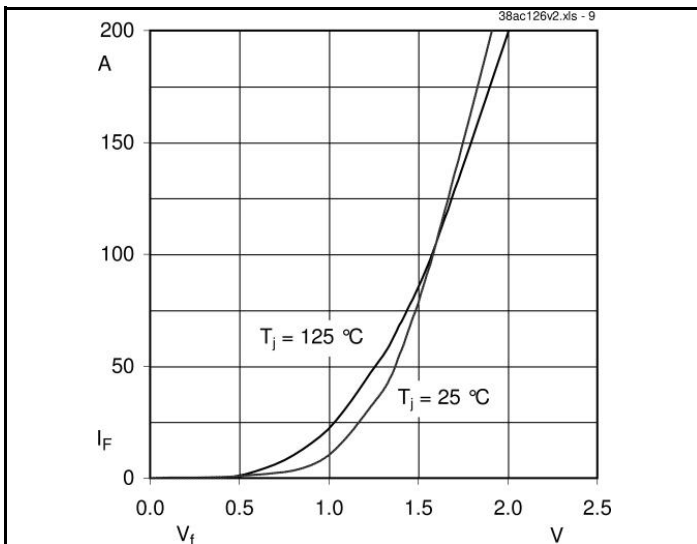
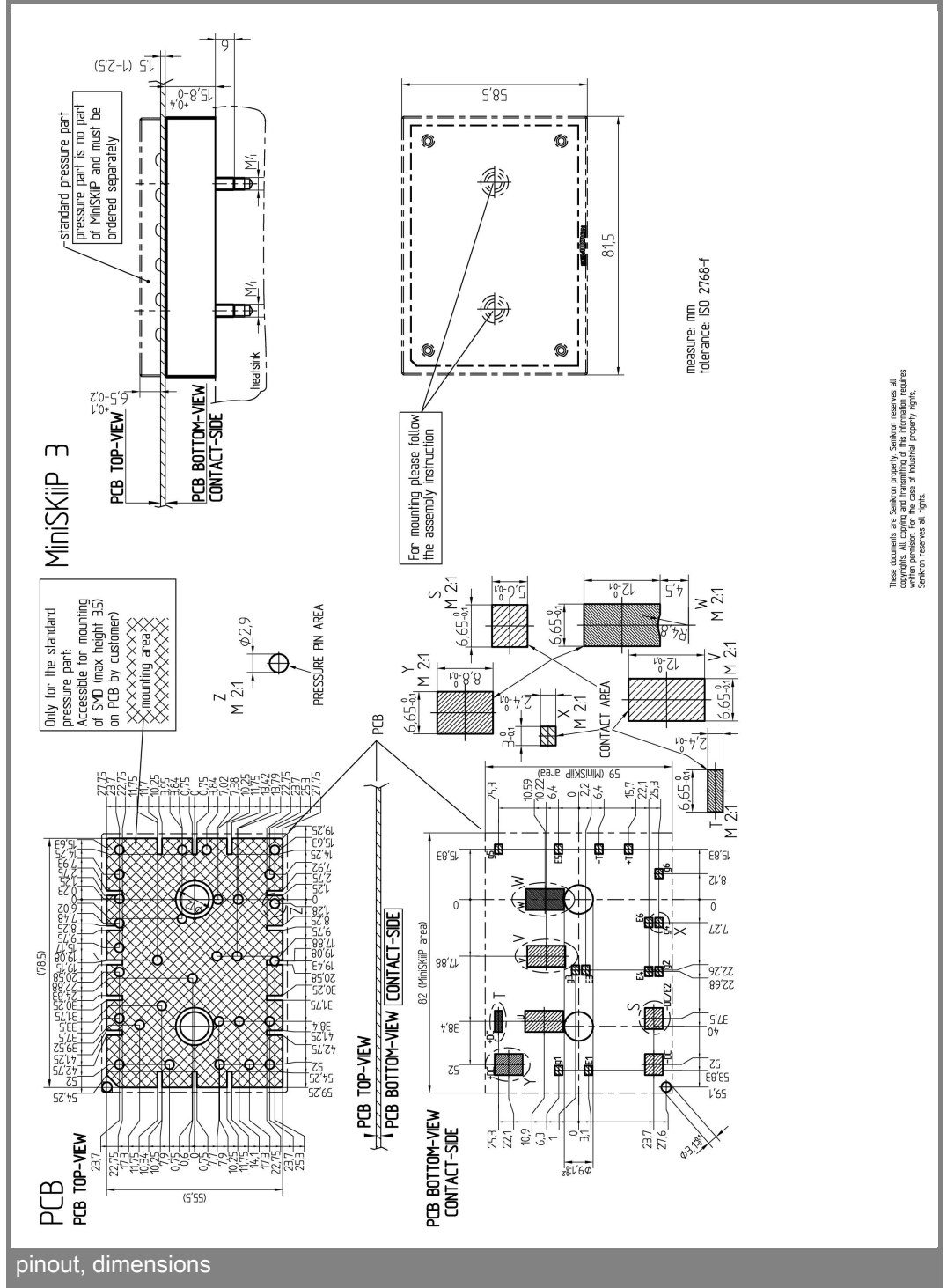
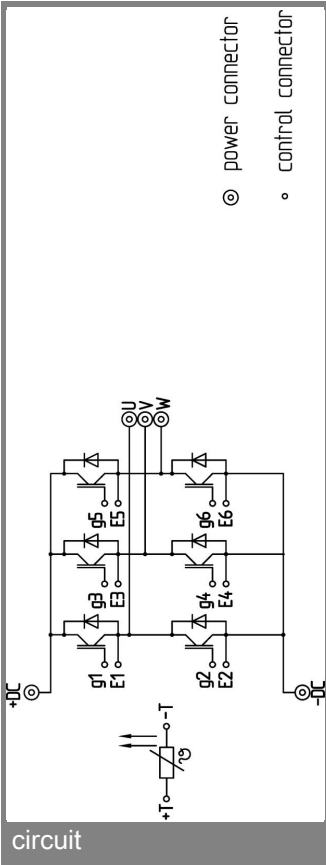

Fig. 9 Typ. freewheeling diode forward characteristic



These documents are SEMIKRON property. SEMIKRON reserves all
copyrights. All rights and transferring of this information requires
written permission from SEMIKRON. SEMIKRON reserves all rights.

This is an electrostatic discharge sensitive device (ESDS), international standard IEC 60747-1, Chapter IX.

This technical information specifies semiconductor devices but promises no characteristics. No warranty or guarantee expressed or implied is made regarding delivery, performance or suitability.