

SEMiX 904GB126HD ...

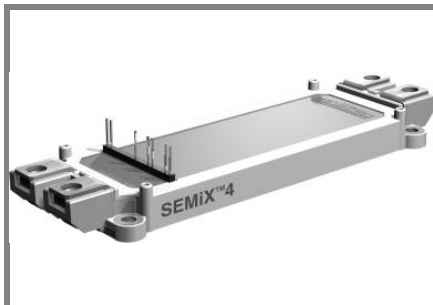

SEMiX® 4

Trench IGBT Modules

SEMiX 904GB126HD

SEMiX 904GAL126HD

SEMiX 904GAR126HD

Target Data

Features

- Homogeneous Si
- Trench = Trenchgate technology
- $V_{CE(sat)}$ with positive temperature coefficient
- High short circuit capability

Typical Applications

- AC inverter drives
- UPS
- Electronic welders

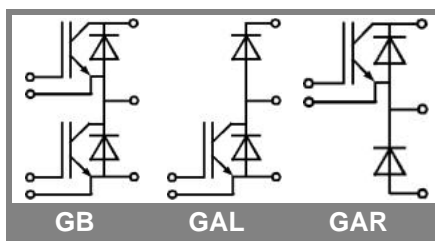

Absolute Maximum Ratings		$T_c = 25\text{ }^\circ\text{C}$, unless otherwise specified	
Symbol	Conditions	Values	Units
IGBT			
V_{CES}		1200	V
I_C	$T_c = 25\text{ (80) }^\circ\text{C}$	910 (640)	A
I_{CRM}	$t_p = 1\text{ ms}$	1200	A
V_{GES}		± 20	V
T_{vj} (T_{stg})	$T_{OPERATION} \leq T_{stg}$	- 40 ... + 150 (125)	$^\circ\text{C}$
V_{isol}	AC, 1 min.	4000	V
Inverse diode			
I_F	$T_c = 25\text{ (80) }^\circ\text{C}$	710 (480)	A
I_{FRM}	$t_p = 1\text{ ms}$	1200	A
I_{FSM}	$t_p = 10\text{ ms; sin.; } T_j = 25\text{ }^\circ\text{C}$	3600	A

Characteristics		$T_c = 25\text{ }^\circ\text{C}$, unless otherwise specified			
Symbol	Conditions	min.	typ.	max.	Units
IGBT					
$V_{GE(th)}$	$V_{GE} = V_{CE}, I_C = 24\text{ mA}$	5	5,8	6,5	V
I_{CES}	$V_{GE} = 0, V_{CE} = V_{CES}, T_j = 25\text{ () }^\circ\text{C}$			3	mA
$V_{CE(TO)}$	$T_j = 25\text{ (125) }^\circ\text{C}$		1 (0,9)	1,2 (1,1)	V
r_{CE}	$V_{GE} = 15\text{ V}, T_j = 25\text{ (125) }^\circ\text{C}$		1,17 (1,83)	1,6 (2,3)	m Ω
$V_{CE(sat)}$	$I_{Cnom} = 600\text{ A}, V_{GE} = 15\text{ V}, T_j = 25\text{ (125) }^\circ\text{C}$, chip level		1,7 (2)	2,15 (2,45)	V
C_{ies}	under following conditions		43		nF
C_{oes}	$V_{GE} = 0, V_{CE} = 25\text{ V}, f = 1\text{ MHz}$		2,3		nF
C_{res}			2		nF
L_{CE}			22		nH
$R_{CC'+EE'}$	terminal-chip, $T_c = 25\text{ (125) }^\circ\text{C}$		0,7 (1)		m Ω
$t_{d(on)}/t_r$	$V_{CC} = 600\text{ V}, I_{Cnom} = 600\text{ A}$		441 / 83		ns
$t_{d(off)}/t_f$	$V_{GE} = \pm 15\text{ V}$		706 / 127		ns
$E_{on} (E_{off})$	$R_{Gon} = R_{Goff} = 1,6\text{ }^\circ\Omega, T_j = 125\text{ }^\circ\text{C}$		60 (88)		mJ
Inverse diode					
$V_F = V_{EC}$	$I_{Fnom} = 600\text{ A}; V_{GE} = 0\text{ V}; T_j = 25\text{ (125) }^\circ\text{C}$, chip level		1,6 (1,6)	1,8 (1,8)	V
$V_{(TO)}$	$T_j = 25\text{ (125) }^\circ\text{C}$		1 (0,8)	1,1 (0,9)	V
r_T	$T_j = 25\text{ (125) }^\circ\text{C}$		1 (1,3)	1,2 (1,5)	m Ω
I_{RRM}	$I_{Fnom} = 600\text{ A}; T_j = 25\text{ (125) }^\circ\text{C}$		625		A
Q_{rr}	$di/dt = 8400\text{ A}/\mu\text{s}$		165		μC
E_{rr}	$V_{GE} = -15\text{ V}$		75		mJ
Thermal characteristics					
$R_{th(j-c)}$	per IGBT			0,042	K/W
$R_{th(j-c)D}$	per Inverse Diode			0,09	K/W
$R_{th(j-c)FD}$	per FWD				K/W
$R_{th(c-s)}$	per module		0,03		K/W
Temperature sensor					
R_{25}	$T_c = 25\text{ }^\circ\text{C}$		5 \pm 5%		k Ω
$B_{25/85}$	$R_2 = R_1 \exp[B(1/T_2 - 1/T_1)]; T[K]; B$		3420		K
Mechanical data					
M_s/M_t	to heatsink (M5) / for terminals (M6)	3/2,5		5 / 5	Nm
w			390		g

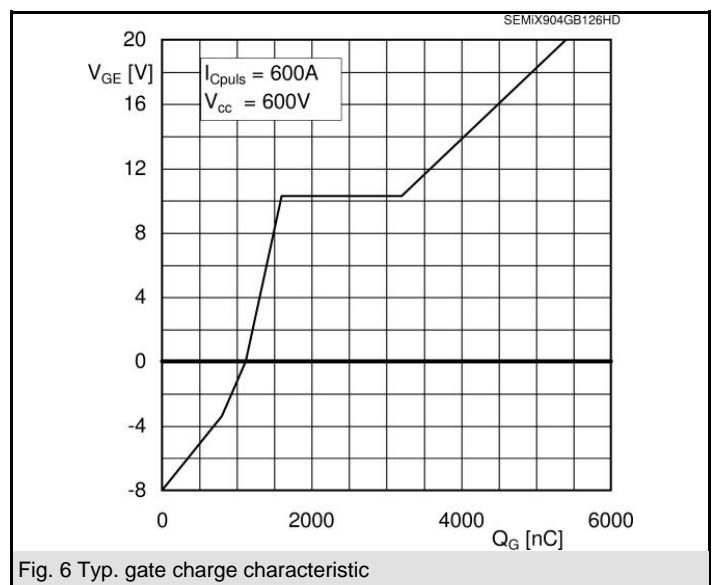
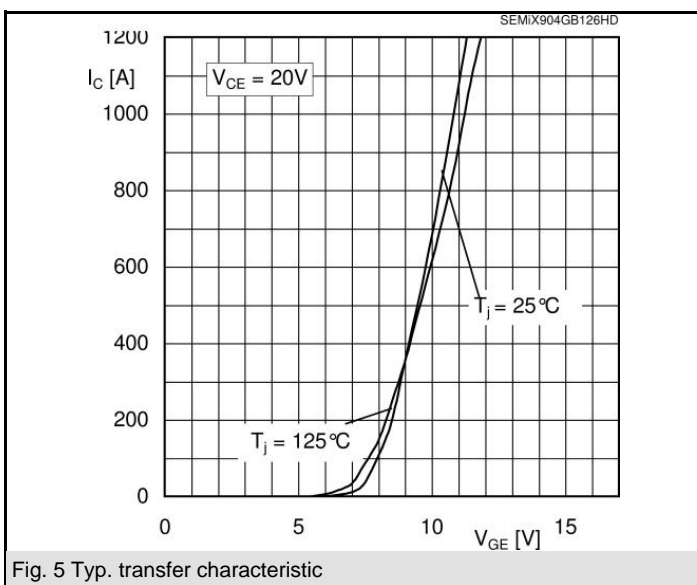
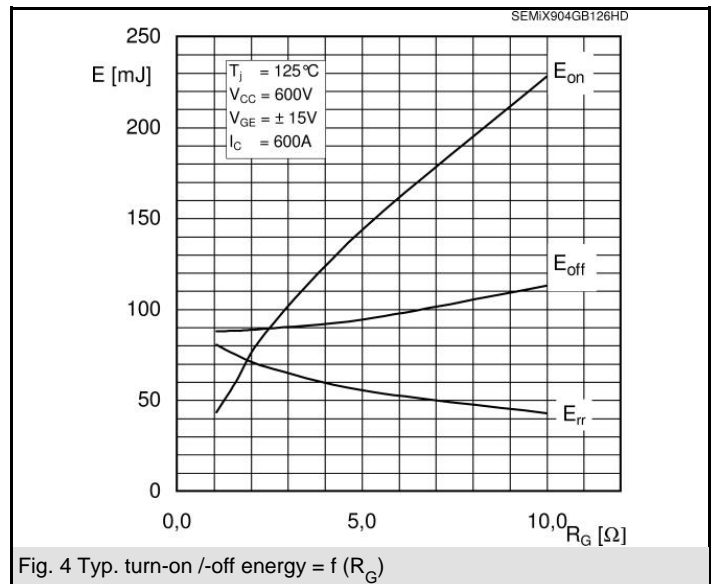
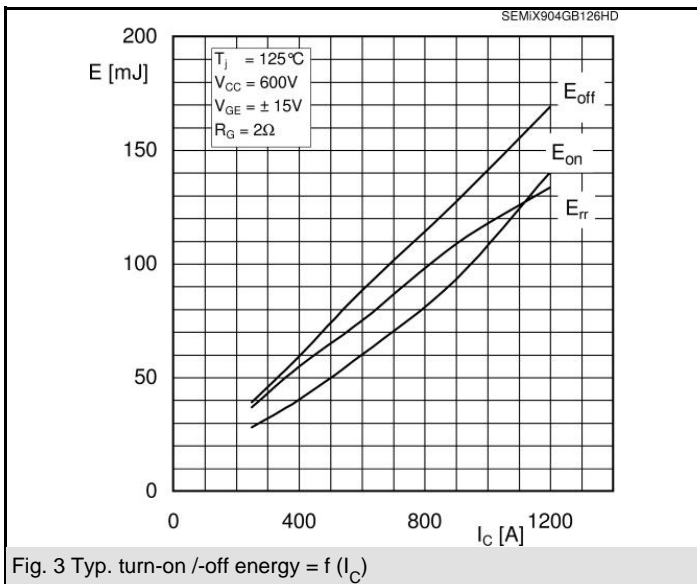
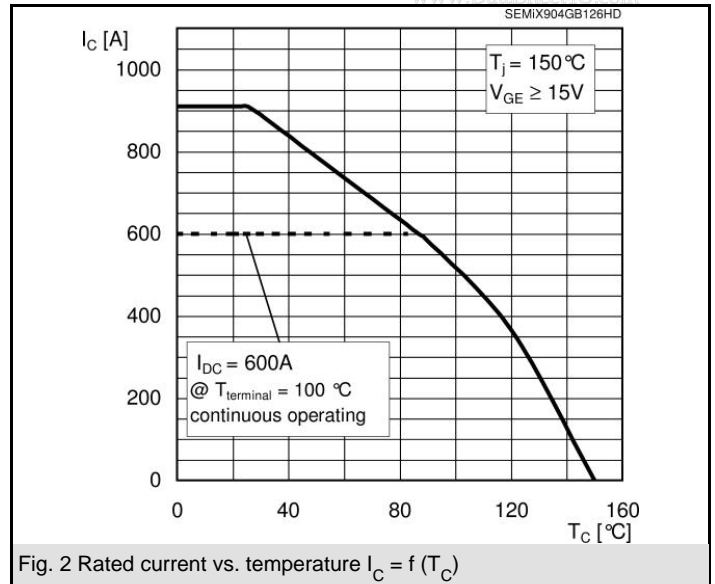
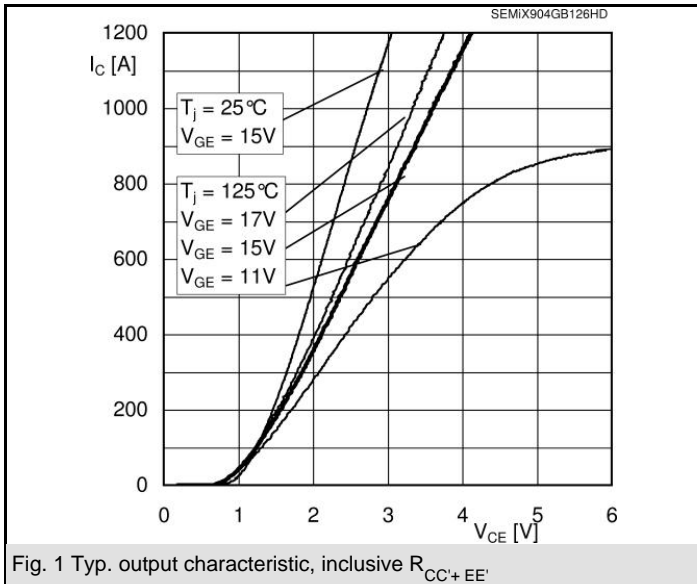

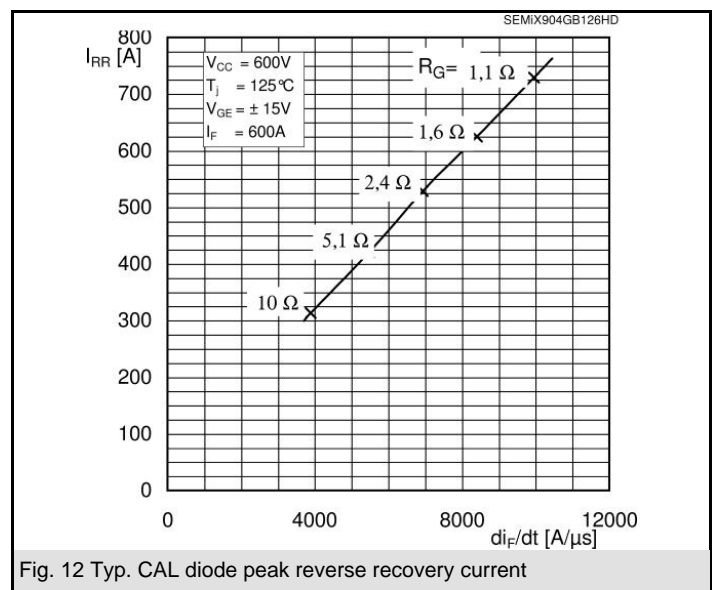
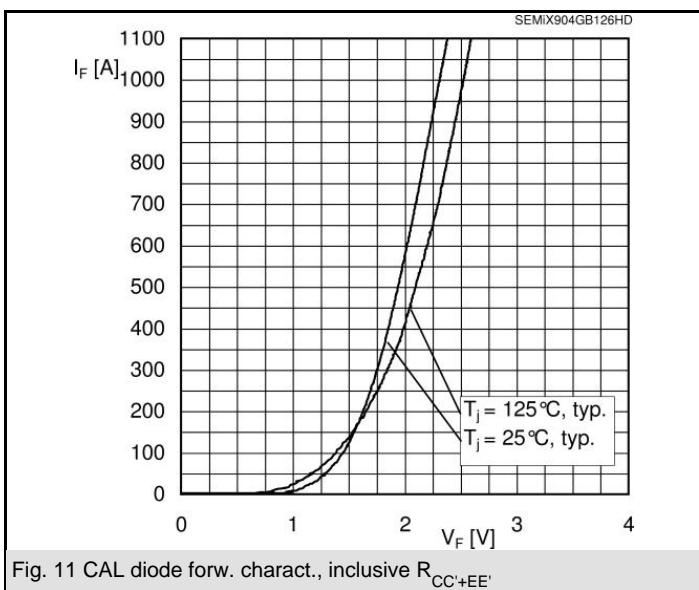
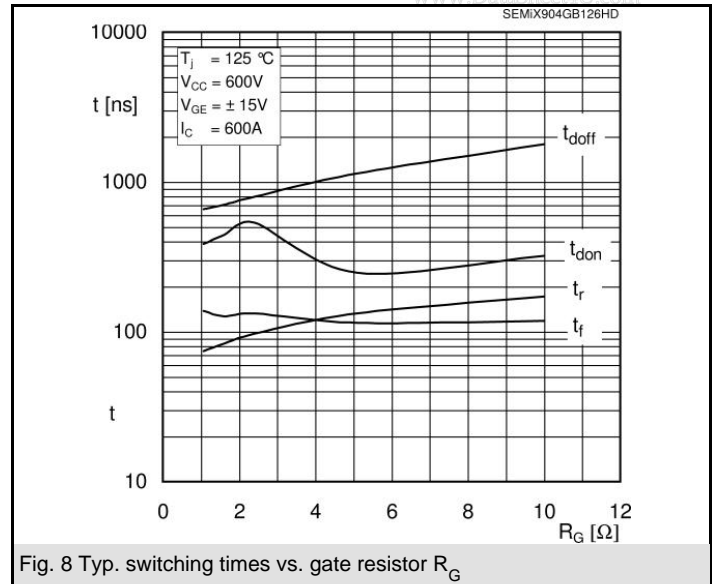
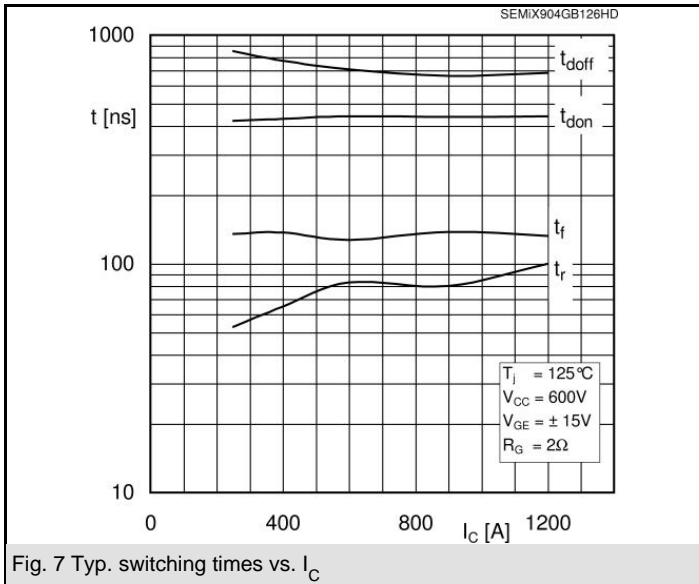

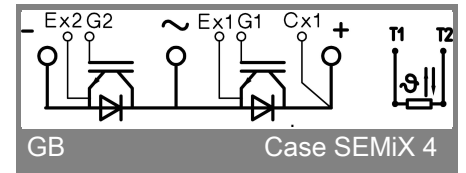
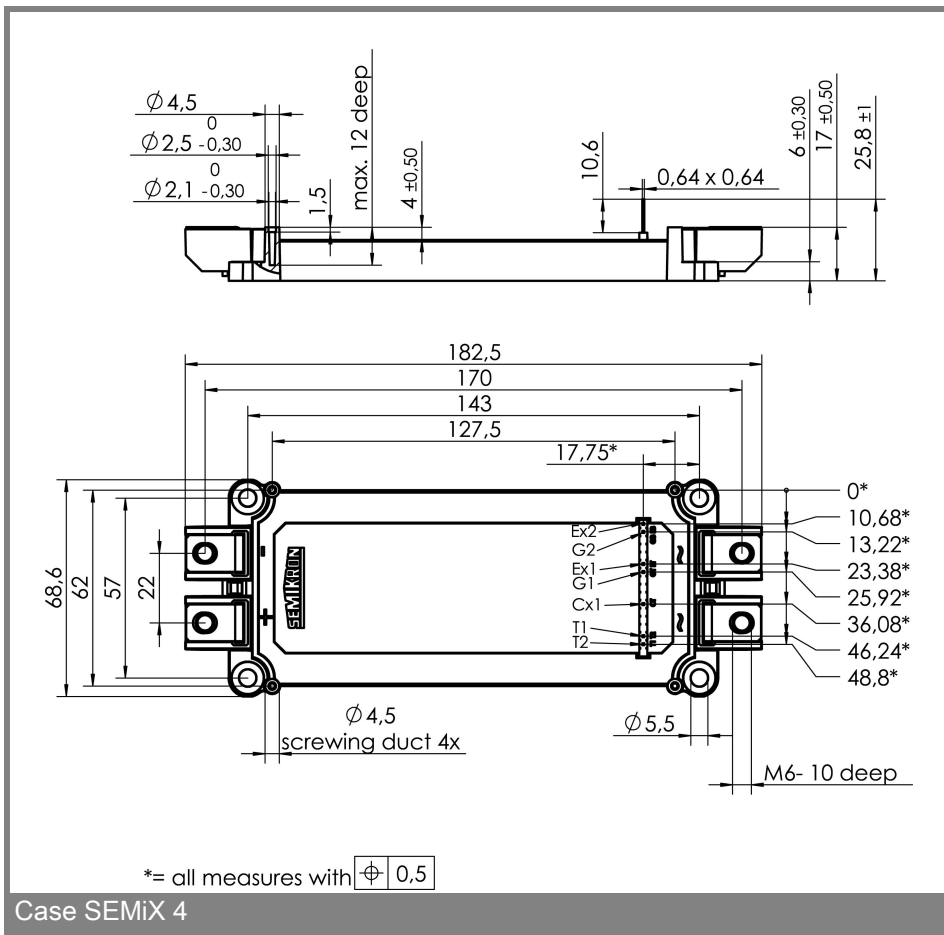
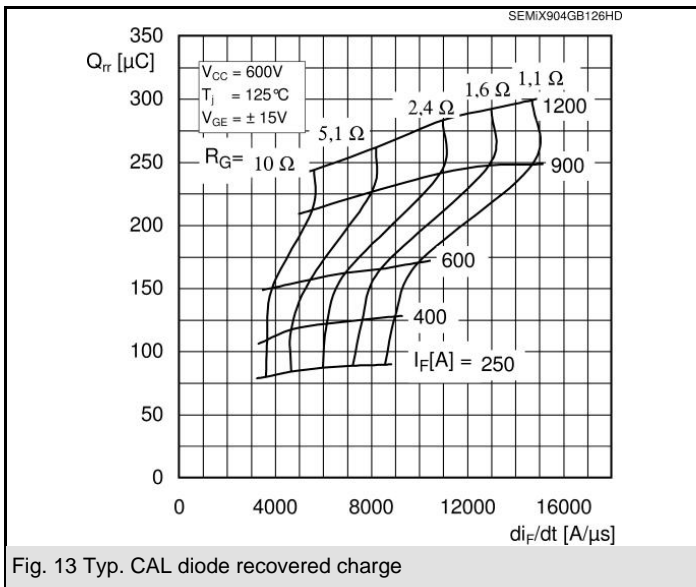

This is an electrostatic discharge sensitive device (ESDS), international standard IEC 60747-1, Chapter IX.

This technical information specifies semiconductor devices but promises no characteristics. No warranty or guarantee expressed or implied is made regarding delivery, performance or suitability.