

AC Servo System

1S Series



EtherCAT

Optimized installation and setup
Increased machine productivity
Global availability and global conformance

State of the art servo technology applied to general purpose

Improved machine design. Increased machine productivity

Designed to meet the machine requirements, the 1S servo technology optimizes the full cycle, through the machine design, installation and commissioning tasks and finally to the maintenance once in production. In addition to the traditional motion solution, the 1S servo offers high resolution multi-turn encoder without battery backup, safety network built-in and improved loop control allowing accurate and higher machine productivity.

Optimized installation and commissioning tasks

Cabinet size reduction:

- Compact servo drive with same height throughout the whole power range

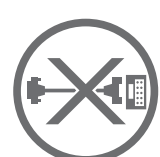

Servo features

- Power range from 100 W to 3 kW - 100/200/400V
- 23 bit high resolution encoder
- 350% momentary maximum torque (200 V, 750 W max.)
- Battery-free absolute multi-turn encoder
- Improved loop control for low overshoot and quick settling time
- Safety function built-in:
 - Hardwired Safe Torque Off: EN ISO 13849-1(Cat.3 PLe), EN61508(SIL3), EN62061(SIL3), EN61800-5-2(STO)
 - Safety over EtherCAT(FSoE): EN ISO 13849-1(Cat.3 PLd), EN61508(SIL2), EN62061(SIL2), EN61800-5-2(STO)

- Fast and secure screw-less push-in in control I/O connector and brake interlock connector
- Pluggable connectors in all connectors for easy pre-wiring and system maintenance
- Direct wiring of I/O signals. No need for terminal block units

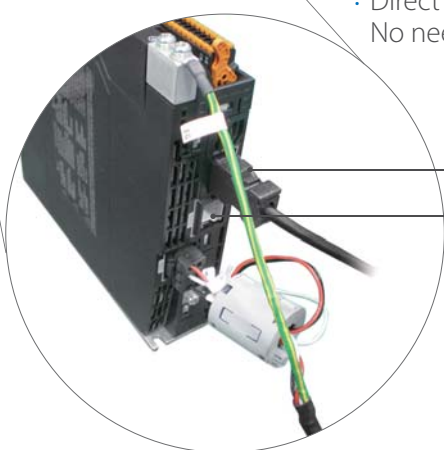

Pre-assembled motor cables

Embedded relay for direct motor brake control



Simplified machine design and maintenance

- No battery, no maintenance
- No need for homing sequence improving machine uptime
- 23 bit high resolution encoder as standard
- Absolute multi-turn encoder design without mechanics: 16 bits, 65536 turns
- Compact and smaller motor size

50% setup time reduction*



Servo sizing

- Servo sizing tool for the entire machine
- Graphical environment of the kinematic chain
- Electronic CAM import from Sysmac Studio



System configuration

- NJ project auto-builder from servo sizing file
- Quick setup wizard for key parameters
- Parameters transfer in less than 400 ms



Gain tuning & test run

- "Best effort" feature for quick stabilization time
- Easy tuning with intelligent gain search in less than 2 minutes
- Wizard for tuning, test run & monitoring
- Advanced tuning simulation to reduce testing effort and prevent machine damage

PATENT PENDING

Save 40%*

Save 60%*

Save 50%*

*Performance comparison with previous Omron products based on Omron investigation in March 2016.

Totally integrated, totally in control

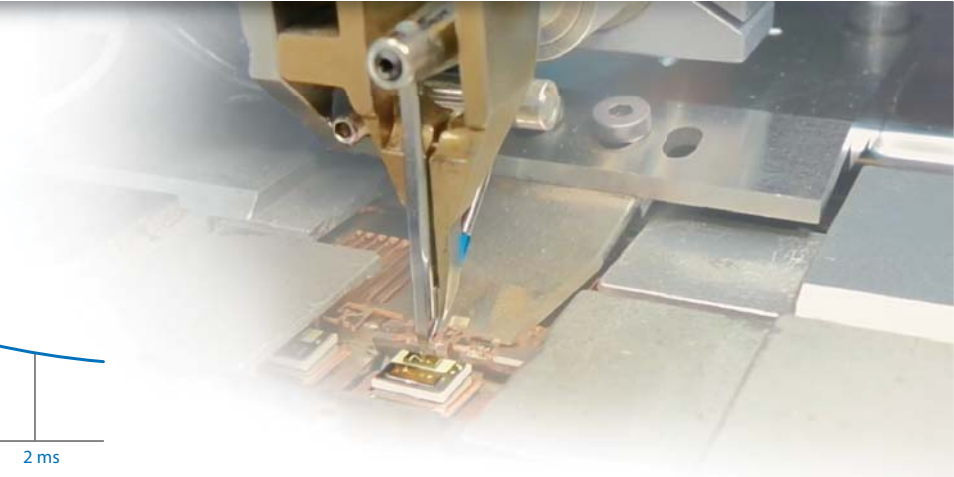
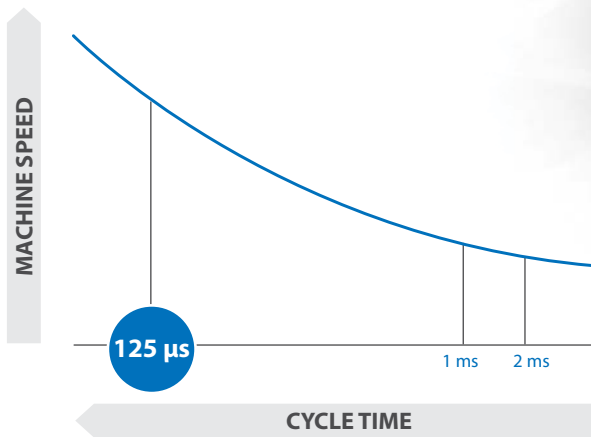

HIGHER PRODUCTIVITY

125 μs system cycle

- Faster machine speed keeping same accuracy
- Accurate profile generation in the controller
- The 23 bit high resolution encoder in combination with the improved loop control provide an accurate following profile

EtherNet/IP™



NJ/NX series Machine Controller

EtherCAT®



NX Safety

INTEGRATED SAFETY

Safety control via EtherCAT

- Simplified safety installation
- Reduction of safety devices
- Safety function built-in: Fail Safe over EtherCAT (FSoE) Safe Torque Off
- Safety approval: EN ISO 13849-1 (Cat.3 PLd), EN61508(SIL2), EN62061(SIL2), EN61800-5-2(STO)
- Troubleshooter integrated with Sysmac Studio

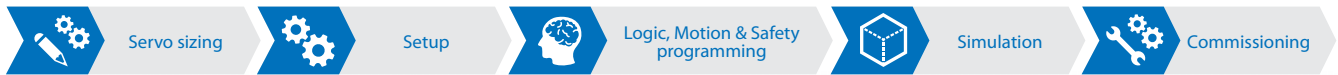

TOTALLY IN CONTROL



Sysmac Studio

- Simplified servo setup: Direct use of servo sizing calculation
- Open standard IEC 61131-3 programming
- Standard PLCopen Function Blocks for Motion and Safety
- Sysmac Library for fast engineering and optimized machine availability
 - Application libraries
 - Optimized productivity
 - Predictive maintenance
 - Reduced downtime



Safety over
EtherCAT

1S Servo



Sysmac Automation Platform

The integrated platform

Sysmac is an integrated automation platform dedicated to providing complete control and management of your automation plant. At the core of this platform, the Machine Controller series offers synchronous control of all machine devices and advanced functionality such as motion, robotics and database connectivity. This multidisciplinary concept allows you to simplify solution architecture, reduce programming and optimize productivity.



Software



Sysmac Studio, the integrated software

- One single tool for logic sequence, motion, safety, robotics, vision and HMI
- Fully compliant with open standard IEC 61131-3
- PLCopen Function Blocks for Motion and Safety
- Supports Ladder, Structured Text and In-Line ST programming with a rich instruction set
- CAM editor for easy programming of complex motion profiles
- Database Connectivity Function Block library

Sysmac Library



The Sysmac Library is a collection of software functional components that can be used in programs for the NJ/NX Machine Automation Controllers.

Please download it from following URL and install to Sysmac Studio.

http://www.ia.omron.com/sysmac_library/

- EtherCAT 1S Series Library: The EtherCAT 1S Series Library is used to initialize the absolute encoder, back up and restore the parameters for an OMRON 1S-series Servo Drive with built-in EtherCAT communications. You can use this library to reduce manpower of programming when implementing the processing for a Servo Drive.



Sysmac servo family

Machine Controller

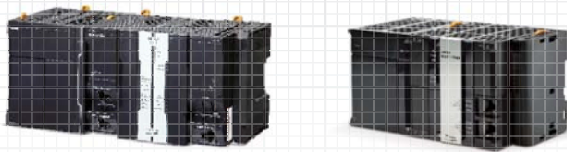

NJ/NX series

- Logic sequence, Motion, Safety, Robotics and Database connection functionality
- Scalable motion control: CPUs from 2 up to 256 axes
- IEC 61131-3 controller
- PLCopen Function Blocks for Motion Control and Safety
- Advanced motion with Robotics functionality
- Built-in EtherCAT and EtherNet/IP ports

Motion

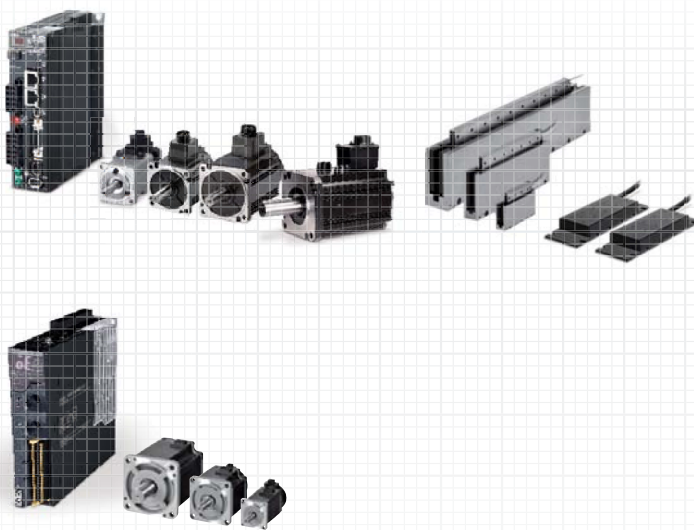

G5 Servo System - Wide functionality and scalability

- Servo drive for rotary or linear motors
- Rotary motor: Up to 15 kW
- Iron-core and Ironless linear motor models: Up to 2100 N peak force
- Safety function: STO
- Full closed loop control

1S Servo System - General purpose servo

- Servo drive for rotary motors
- Up to 3 kW
- Safety function: STO

R88M-1□/R88D-1SN□-ECT

Best Machine Architecture

- Simple installation and wiring contributes to board design efficiency
- EtherCAT Communications Cycle of 125 μs
- Achievement of Safety on EtherCAT Network
- Supports two-degree-of-freedom control
- Battery-free system reduces maintenance and space
- Comes equipped with a 23-bit ABS encoder
- 350% momentary maximum torque (200 V, 750 W max.)



System Configuration

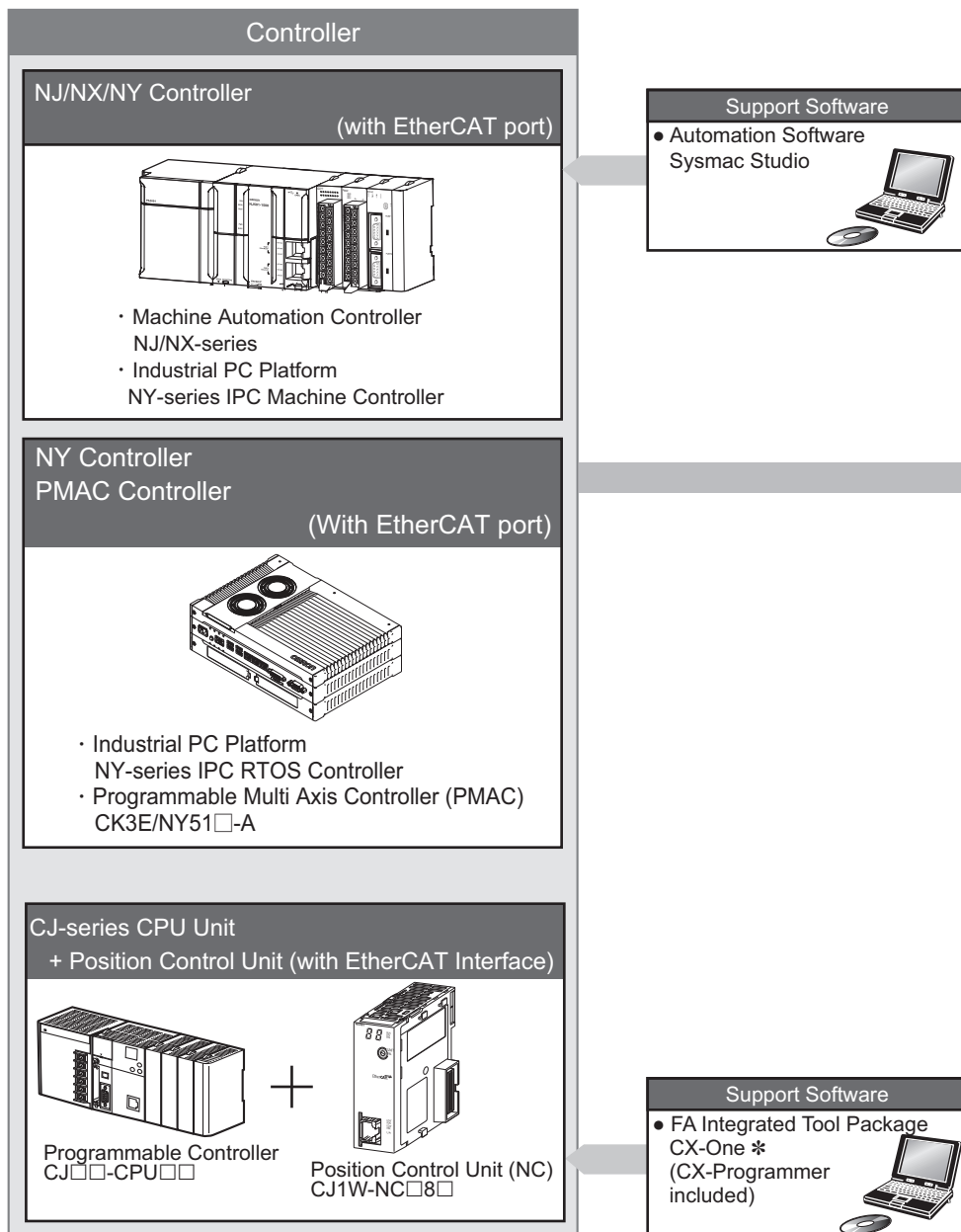

* You cannot use the CX-One to make the settings of 1S-series Servo Drives. Obtain the Sysmac Studio.

Note: PMAC is an abbreviation for Programmable Multi Axis Controller.

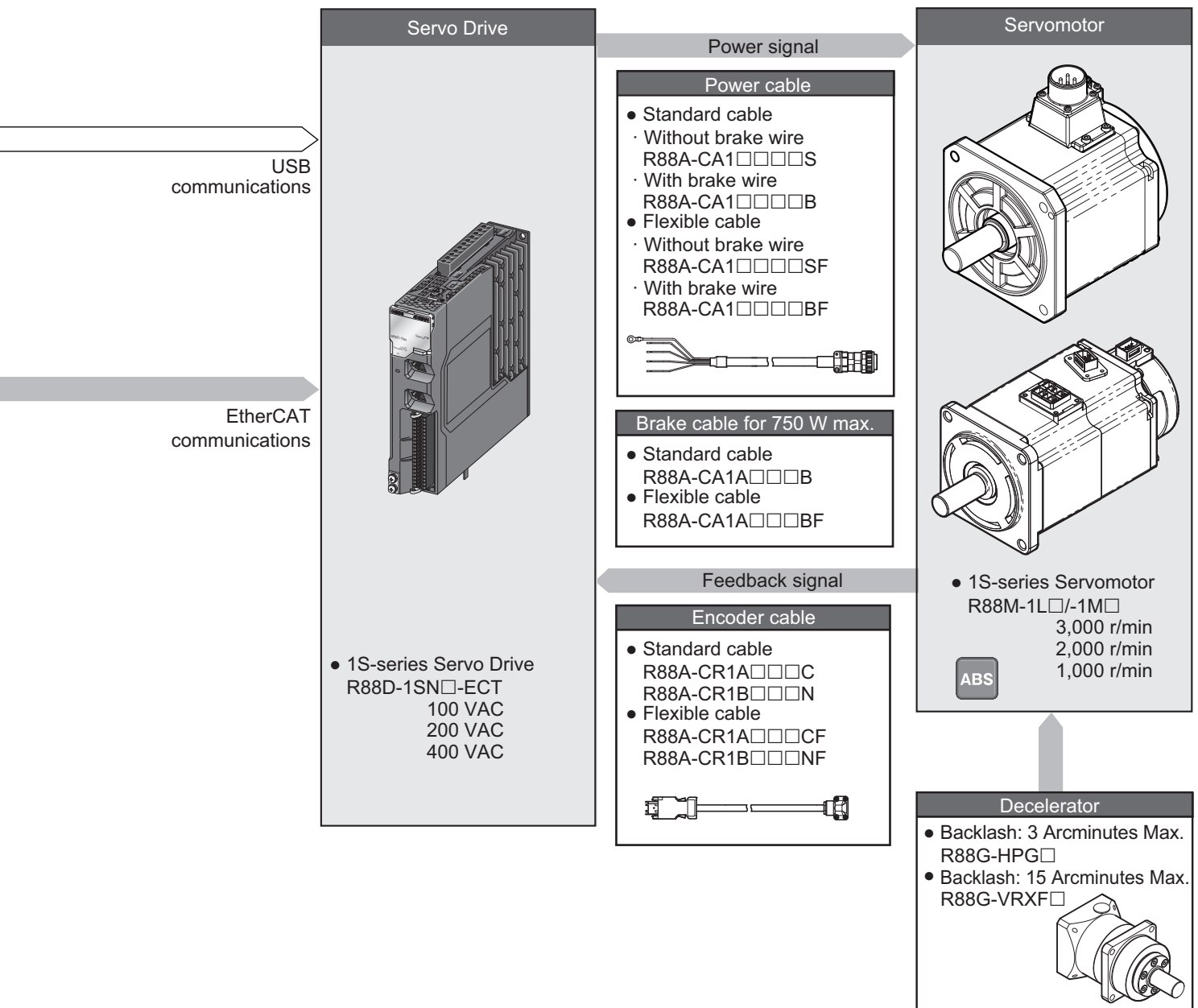

R88D-1SN□-ECT

Contents

- Ordering Information
- Specifications
- EtherCAT Communication Specifications
- Version Information
- Names and Functions
- Dimensions



Ordering Information

Refer to the Ordering Information.

Specifications

General Specifications

Item		Specifications	
Operating ambient temperature and humidity		0 to 55°C, 90% max. (with no condensation)	
Storage ambient temperature and humidity		-20 to 65°C, 90% max. (with no condensation)	
Operating and storage atmosphere		No corrosive gases	
Operating altitude		1,000 m max.	
Vibration resistance		10 to 60 Hz and at an acceleration of 5.88 m/s ² or less (Not to be run continuously at the resonance frequency)	
Insulation resistance		Between power supply terminals/power terminals and PE terminals: 0.5 MΩ min. (at 500 VDC)	
Dielectric strength		Between power supply terminals/power terminals and PE terminals: 1,500 VAC for 1 min (at 50/60 Hz)	
Protective structure		IP20 (Built into IP54 panel)	
International standard	EU Directives	EMC Directive	EN 61800-3 second environment, C3 category (EN61326-3-1; Functional Safety)
		Low Voltage Directive	EN 61800-5-1
		Machinery Directive	EN ISO 13849-1 (Cat.3), EN 61508, EN 62061, EN 61800-5-2
	UL standards	UL 61800-5-1	
	CSA standards	CSA C22.2 No. 274	
	Korean Radio Regulations (KC)	Compliant	
	Australian EMC Labelling Requirements (RCM)	Compliant	

Note: The above items reflect individual evaluation testing. The results may differ under compound conditions.

The detail of Machinery Directive is as follows:

The STO function via safety input signals: EN ISO 13849-1 (Cat3 PLe), EN 61508 (SIL3), EN 62061 (SIL3), EN 61800-5-2 (STO)

The STO function via EtherCAT communications: EN ISO 13849-1 (Cat.3 PLd), EN 61508 (SIL2), EN 62061 (SIL2), EN 61800-5-2 (STO)

Precautions for Correct Use

Disconnect all connections to the Servo Drive before attempting a megger test (insulation resistance measurement) on a Servo Drive. Not doing so may result in the Servo Drive failure.

Do not perform a dielectric strength test on the Servo Drive. Internal elements may be damaged.

Characteristics

100-VAC Input Models

Servo Drive model (R88D-)			1SN01L-ECT	1SN02L-ECT	1SN04L-ECT
Item			100 W	200 W	400 W
Input	Main circuit	Power supply voltage	Single-phase 100 to 120 VAC (85 to 132 V) *1 Rise time 500 ms max. *2		
		Frequency	50/60 Hz (47.5 to 63 Hz) *1		
	Control circuit	Power supply voltage	24 VDC (21.6 to 26.4 V)		
		Current consumption *3	600 mA		
	Rated input current [A (rms)] (Main circuit power supply voltage: 120 VAC)	Single-phase	2.9	4.9	8.4
		3-phase	---	---	---
Output	Rated current [A (rms)]	1.5	2.5	4.8	
	Maximum current [A (rms)]	4.7	8.4	14.7	
Heat value [W]	Main circuit	14.8	23.4	33.1	
	Control circuit	11	11	13.2	
Applicable Servomotor rated output [W]		100	200	400	
3,000-r/min Servomotor (R88M-)	Batteryless 23-bit ABS	1M10030S	1M20030S	1M40030S	
Hold time at momentary power interruption (Main circuit power supply voltage: 100 VAC)		10 ms (Load condition: rated output) *4			
Weight [kg]		1.2	1.5	1.9	

*1. The values outside parentheses indicate the rated value, and the values inside parentheses indicate the range of acceptable variation.

*2. If the power supply is turned ON slowly, a Regeneration Circuit Error Detected during Power ON (Error No. 14.02) may occur. Check that the power supply has a capacity sufficiently greater than the total capacity of the Servo Drive and the peripheral devices.

*3. Select a DC power supply in consideration of the current values that are specified in the current consumption.

The rated current value that is printed on the product nameplate is a condition to apply the 1S-series product for the UL/Low Voltage Directive. Therefore, you do not need to consider it when you select a DC power supply for each model.

*4. The control power supply is not specified here as long as a DC power supply that meets the following conditions is used.

Reinforced insulation or double insulation, and the output hold time of 10 ms or more.

AC Servo System 1S-series

200-VAC Input Models

Servo Drive model (R88D-)			1SN01H-ECT	1SN02H-ECT	1SN04H-ECT	1SN08H-ECT
Item			100 W	200 W	400 W	750 W
Input	Main circuit	Power supply voltage	Single-phase and 3-phase 200 to 240 VAC (170 to 252 V) *1 Rise time 500 ms max. *2			
		Frequency	50/60 Hz (47.5 to 63 Hz) *1			
	Control circuit	Power supply voltage	24 VDC (21.6 to 26.4 V)			
		Current consumption *3	600 mA			
	Rated current [A (rms)] (Main circuit power supply voltage: 240 VAC)	Single-phase	1.8	2.7	4.6	7.3
3-phase		1.0	1.5	2.7	4.0	
Output	Rated current [A (rms)]	0.8	1.5	2.5	4.6	
	Maximum current [A (rms)]	3.1	5.6	9.1	16.9	
Heat value [W]	Main circuit	15.7/15.3 *5	15.2/14.6 *5	22.4/22.4 *5	40/39.7 *5	
	Control circuit	11	11	11	13.2	
Applicable Servomotor rated output [W]		100	200	400	750	
3,000-r/min Servomotor (R88M-)	Batteryless 23-bit ABS	1M10030T	1M20030T	1M40030T	1M75030T	
2,000-r/min Servomotor (R88M-)	Batteryless 23-bit ABS	---	---	---	---	
1,000-r/min Servomotor (R88M-)	Batteryless 23-bit ABS	---	---	---	---	
Hold time at momentary power interruption (Main circuit power supply voltage: 200 VAC)		10 ms (Load condition: rated output) *5				
Weight [kg]		1.2	1.2	1.5	2.0	

Servo Drive model (R88D-)			1SN10H-ECT	1SN15H-ECT	1SN20H-ECT	1SN30H-ECT
Item			1 kW	1.5 kW	2 kW	3 kW
Input	Main circuit	Power supply voltage	3-phase 200 to 240 VAC (170 to 252 V) *1	Single-phase and 3-phase 200 to 240 VAC (170 to 252 V) *1	3-phase 200 to 240 VAC (170 to 252 V) *1	
		Frequency	50/60 Hz (47.5 to 63 Hz) *1			
	Control circuit	Power supply voltage	24 VDC (21.6 to 26.4 V)			
		Current consumption *3	600 mA	900 mA		
	Rated current [A (rms)] (Main circuit power supply voltage: 240 VAC)	Single-phase	---	15.7	---	---
3-phase		5.8	9.0	13.0	15.9	
Output	Rated current [A (rms)]	7.7	9.7	16.2	22.3	
	Maximum current [A (rms)]	16.9	28.4	41.0	54.7	
Heat value [W]	Main circuit *4	46.5	85.5/85.5 *5	128.9	167.5	
	Control circuit	13.2	20.4	20.4	20.4	
Applicable Servomotor rated output [W]		1,000	1,500	2,000	3,000	
3,000-r/min Servomotor (R88M-)	Batteryless 23-bit ABS	1L1K030T	1L1K530T	1L2K030T	1L3K030T	
2,000-r/min Servomotor (R88M-)	Batteryless 23-bit ABS	1M1K020T	1M1K520T	1M2K020T	1M3K020T	
1,000-r/min Servomotor (R88M-)	Batteryless 23-bit ABS	1M90010T	---	1M2K010T	1M3K010T	
Hold time at momentary power interruption (Main circuit power supply voltage: 200 VAC)		10 ms (Load condition: rated output) *6				
Weight [kg]		2.0	3.4	3.4	3.4	

*1. The values outside parentheses indicate the rated value, and the values inside parentheses indicate the range of acceptable variation.

*2. If the power supply is turned ON slowly, a Regeneration Circuit Error Detected during Power ON (Error No. 14.02) may occur. Check that the power supply has a capacity sufficiently greater than the total capacity of the Servo Drive and the peripheral devices.

*3. Select a DC power supply in consideration of the current values that are specified in the current consumption.

The rated current value that is printed on the product nameplate is a condition to apply the 1S-series product for the UL/Low Voltage Directive. Therefore, you do not need to consider it when you select a DC power supply for each model.

*4. This is the maximum heating value in applicable Servomotors.

Refer to the table on the next page for the heating value of each applicable Servomotor.

*5. The first value is for single-phase input power and the second value is for 3-phase input power.

*6. The control power supply is not specified here as long as a DC power supply that meets the following conditions is used.

Reinforced insulation or double insulation, and the output hold time of 10 ms or more.

400-VAC Input Models

Use a neutral grounded 400 VAC 3-phase power supply for the 400 VAC input models in order to satisfy the conditions to obtain the standards.

Servo Drive model (R88D-)			1SN06F-ECT	1SN10F-ECT	1SN15F-ECT	1SN20F-ECT	1SN30F-ECT
Item			600 W	1 kW	1.5 kW	2 kW	3 kW
Input	Main circuit	Power supply voltage	3-phase 380 to 480 VAC (323 to 504 V) *1				
		Frequency	50/60 Hz (47.5 to 63 Hz) *1				
	Control circuit	Current consumption *3	900 mA				
		Power supply voltage	24 VDC (21.6 to 26.4 V)				
Output	Rated current [A (rms)] (Main circuit power supply voltage: 480 VAC)	3-phase	2.4	3.1	4.3	6.5	8.4
		Rated current [A (rms)]	1.8	4.1	4.7	7.8	11.3
		Maximum current [A (rms)]	5.5	9.6	14.1	19.8	28.3
Heat value [W]	Main circuit *4	20.2	52.1	77.5	106.8	143.3	
	Control circuit	20.4	20.4	20.4	20.4	20.4	
Applicable Servomotor rated output [W]			600	1,000	1,500	2,000	3,000
3,000-r/min Servomotor (R88M-)	Batteryless 23-bit ABS	---	1L75030C 1L1K030C	1L1K530C	1L2K030C	1L3K030C	
2,000-r/min Servomotor (R88M-)	Batteryless 23-bit ABS	1M40020C 1M60020C	1M1K020C	1M1K520C	1M2K020C	1M3K020C	
1,000-r/min Servomotor (R88M-)	Batteryless 23-bit ABS	---	1M90010C	---	1M2K010C	1M3K010C	
Hold time at momentary power interruption (Main circuit power supply voltage: 400 VAC)			10 ms (Load condition: rated output) *5				
Weight [kg]			3.4	3.4	3.4	3.4	3.4

*1. The values outside parentheses indicate the rated value, and the values inside parentheses indicate the range of acceptable variation.

*2. If the power supply is turned ON slowly, a Regeneration Circuit Error Detected during Power ON (Error No. 14.02) may occur. Check that the power supply has a capacity sufficiently greater than the total capacity of the Servo Drive and the peripheral devices.

*3. Select a DC power supply in consideration of the current values that are specified in the current consumption.

The rated current value that is printed on the product nameplate is a condition to apply the 1S-series product for the UL/Low Voltage Directive. Therefore, you do not need to consider it when you select a DC power supply for each model.

*4. This is the maximum heating value in applicable Servomotors.

Refer to the table below for the heating value of each applicable Servomotor.

*5. The control power supply is not specified here as long as a DC power supply that meets the following conditions is used.
Reinforced insulation or double insulation, and the output hold time of 10 ms or more.

Heating Values of Applicable Servomotors

Servo Drive model	Servomotor model	Main circuit heat value [W]
R88D-1SN10H-ECT	R88M-1L1K030T-□	46.5
	R88M-1M1K020T-□	37.7
	R88M-1M90010T-□	42.9
R88D-1SN15H-ECT	R88M-1L1K530T-□	85.5/85.5
	R88M-1M1K520T-□	84/84
R88D-1SN20H-ECT	R88M-1L2K030T-□	128.9
	R88M-1M2K020T-□	91.3
	R88M-1M2K010T-□	109.1
R88D-1SN30H-ECT	R88M-1L3K030T-□	167.5
	R88M-1M3K020T-□	125.5
	R88M-1M3K010T-□	156.7
R88D-1SN06F-ECT	R88M-1M40020C-□	14.4
	R88M-1M60020C-□	20.2
R88D-1SN10F-ECT	R88M-1L75030C-□	51.1
	R88M-1L1K030C-□	52.1
	R88M-1M1K020C-□	33.4
R88D-1SN15F-ECT	R88M-1M90010C-□	40.2
	R88M-1L1K530C-□	77.5
	R88M-1M1K520C-□	47.9
R88D-1SN20F-ECT	R88M-1L2K030C-□	106.8
	R88M-1M2K020C-□	65.7
	R88M-1M2K010C-□	79.6
R88D-1SN30F-ECT	R88M-1L3K030C-□	143.3
	R88M-1M3K020C-□	96.5
	R88M-1M3K010C-□	115.5

AC Servo System 1S-series

EtherCAT Communications Specifications

Item	Specifications
Communications standard	IEC 61158 Type 12, IEC 61800-7 CiA 402 Drive Profile
Physical layer	100BASE-TX (IEEE802.3)
Connectors	RJ45 × 2 (shielded) ECAT IN: EtherCAT input ECAT OUT: EtherCAT output
Communications media	Recommended media: Twisted-pair cable, which is doubly shielded by the aluminum tape and braid, with Ethernet Category 5 (100BASE-TX) or higher
Communications distance	Distance between nodes: 100 m max.
Process data	Fixed PDO mapping Variable PDO mapping
Mailbox (CoE)	Emergency messages, SDO requests, SDO responses, and SDO information
Synchronization mode and communications cycle	DC Mode (Synchronous with Sync0 Event) Communications cycle: 125 μs, 250 μs, 500 μs, 750 μs, 1 to 10 ms (in 0.25 ms increments) Free Run Mode
Indicators	ECAT-L/A IN (Link/Activity IN) × 1 ECAT-L/A OUT (Link/Activity OUT) × 1 ECAT-RUN × 1 ECAT-ERR × 1
CiA 402 Drive Profile	<ul style="list-style-type: none"> • Cyclic synchronous position mode • Cyclic synchronous velocity mode • Cyclic synchronous torque mode • Profile position mode • Profile velocity mode • Homing mode • Touch probe function • Torque limit function

Version Information

1S-series Servo Drive		Corresponding version	
Model	Unit version	NJ/NX-series CPU Unit	Sysmac Studio
R88D-1SN□-ECT	Version 1.0	NJ: Version 1.11 or later NX: Version 1.11 or later	Version 1.16 or higher
	Version 1.1	NJ: Version 1.11 or later NX: Version 1.11 or later	Version 1.18 or higher
	Version 1.2	NJ: Version 1.11 or later NX: Version 1.11 or later	Version 1.22 or higher

Functions That Were Added or Changed for Each Unit Version

Function		Addition/change	Unit version
Adjustment Function	Multiple Drives Tuning Function	Addition	Ver.1.1
Object	Machine - Inertia Ratio (3001-01 hex)	Change	Ver.1.1
	TDF Position Control - Command Following Gain Selection (3120-10 hex)	Addition	Ver.1.1
	TDF Position Control - Command Following Gain 2 (3120-11 hex)	Addition	Ver.1.1
	TDF Velocity Control - Command Following Gain Selection (3121-10 hex)	Addition	Ver.1.1
	TDF Velocity Control - Command Following Gain 2 (3121-11 hex)	Addition	Ver.1.1
	Command Dividing Function - Interpolation Method Selection in csp (3041-10 hex)	Addition	Ver.1.2
	Runaway Detection (3B71 hex)	Addition	Ver.1.1
	Function Output - Physical Outputs (4602-F1 hex)	Change	Ver.1.2
	External Brake Interlock Relay Output (4663 hex)	Addition	Ver.1.2
	Digital outputs - Physical Outputs (60FE - 01 hex)	Change	Ver.1.2
Error detection function	Runaway Detection	Addition	Ver.1.1
	Synchronization Error	Change	Ver.1.1
	Regeneration Circuit Error Detected during Power ON	Addition	Ver.1.2
Applied Functions	Brake Interlock	Addition	Ver.1.2

Part Names

Servo Drive Part Names

R88D-1SN01L-ECT/-1SN02L-ECT/-1SN04L-ECT/-1SN01H-ECT/
-1SN02H-ECT/-1SN04H-ECT/-1SN08H-ECT/-1SN10H-ECT

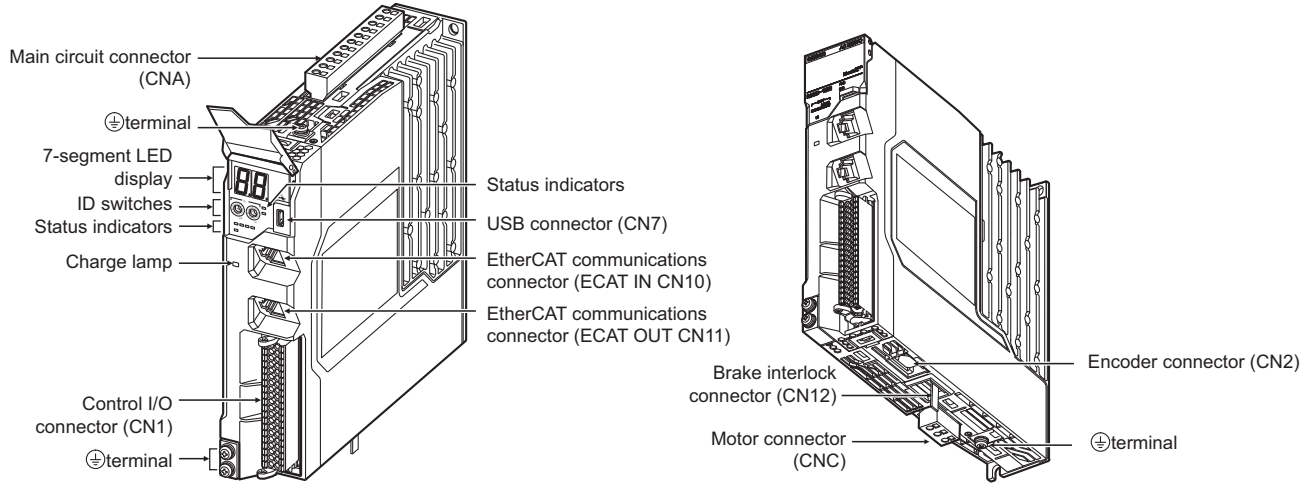

R88D-1SN15H-ECT/-1SN20H-ECT/-1SN30H-ECT/-1SN06F-ECT/
-1SN10F-ECT/-1SN15F-ECT/-1SN20F-ECT/-1SN30F-ECT

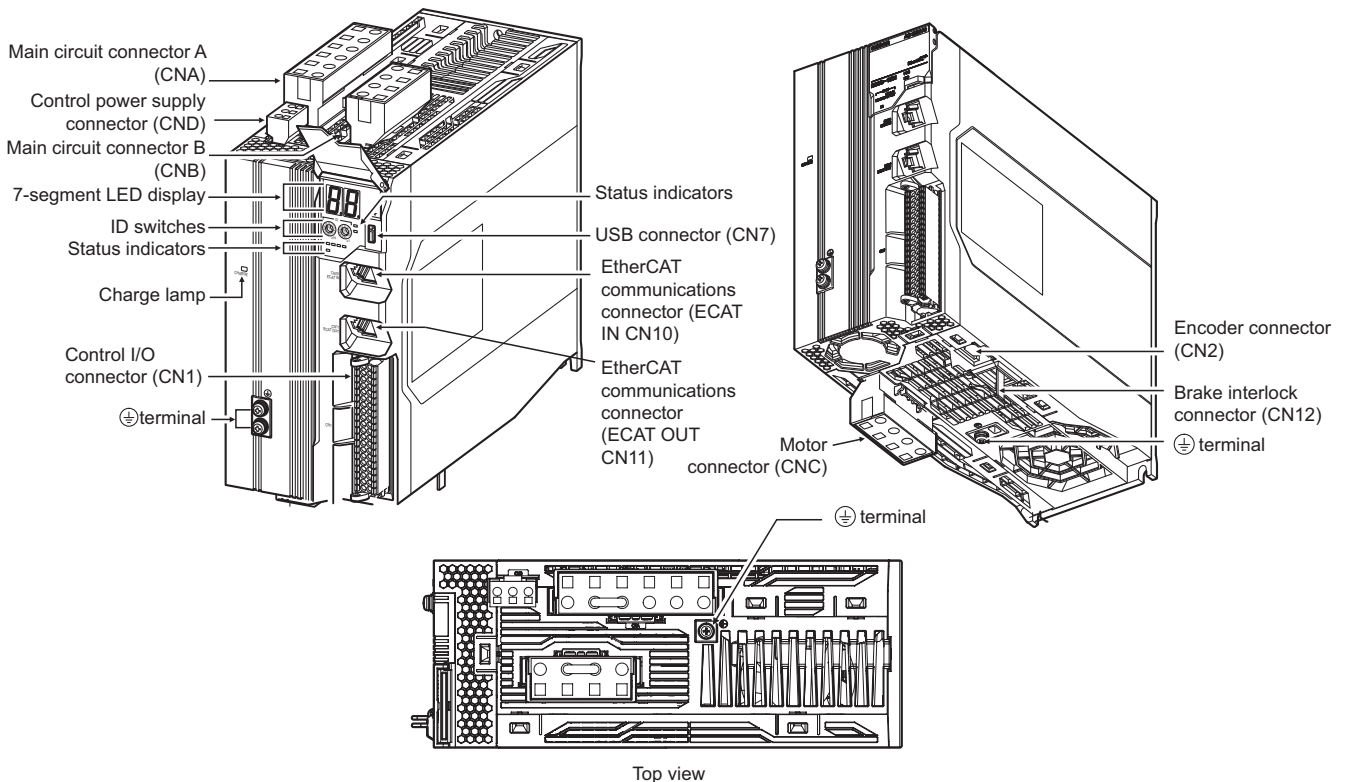

Servo Drive Functions

Status Indicators

The following seven indicators are mounted.

Name	Color	Description
PWR	Green	Displays the status of control power supply.
ERR	Red	Gives the Servo Drive error status.
ECAT-RUN	Green	Displays the EtherCAT communications status.
ECAT-ERR	Red	Displays the EtherCAT communications status.
ECAT-L/A IN, ECAT-L/A OUT	Green	Lights or flashes according to the status of a link in the EtherCAT physical layer.
FS	Red/green	Displays the safety communications status.

AC Servo System 1S-series

7-segment LED Display

A 2-digit 7-segment LED display shows error numbers, the Servo Drive status, and other information.

ID Switches

Two rotary switches (0 to F hex) are used to set the EtherCAT node address.

Charge Lamp

Lights when the main circuit power supply carries electric charge.

Control I/O Connector (CN1)

Used for command input signals, I/O signals, and as the safety device connector. The short-circuit wire is installed on the safety signals before shipment.

Encoder Connector (CN2)

Connector for the encoder installed in the Servomotor.

EtherCAT Communications Connectors (ECAT IN CN10, ECAT OUT CN11)

These connectors are for EtherCAT communications.

USB Connector (CN7)

USB-Micro B Communications connector for the computer. This connector enables USB 2.0 Full Speed (12 Mbps) communications.

Brake Interlock Connector (CN12)

Used for brake interlock signals.

Main Circuit Connector (CNA)

Connector for the main circuit power supply input, control power supply input, external regeneration resistor, and DC reactor.

Applicable models: R88D-1SN01L-ECT/-1SN02L-ECT/-1SN04L-ECT/-1SN01H-ECT/-1SN02H-ECT/-1SN04H-ECT/-1SN08H-ECT/-1SN10H-ECT

Main Circuit Connector A (CNA)

Connector for the main circuit power supply input and external regeneration resistor.

Applicable models: R88D-1SN15H-ECT/-1SN20H-ECT/-1SN30H-ECT/-1SN06F-ECT/-1SN10F-ECT/-1SN15F-ECT/-1SN20F-ECT/-1SN30F-ECT

Main Circuit Connector B (CNB)

Connector for a DC reactor.

Applicable models: R88D-1SN15H-ECT/-1SN20H-ECT/-1SN30H-ECT/-1SN06F-ECT/-1SN10F-ECT/-1SN15F-ECT/-1SN20F-ECT/-1SN30F-ECT

Control Power Supply Connector (CND)

Connector for control power supply input.

Applicable models: R88D-1SN15H-ECT/-1SN20H-ECT/-1SN30H-ECT/-1SN06F-ECT/-1SN10F-ECT/-1SN15F-ECT/-1SN20F-ECT/-1SN30F-ECT

Motor Connector (CNC)

Connector for the power line to the phase U, V, and W of the Servomotor. The connector differs depending on the model.

⊕ Terminal

The number of ⊕ terminals of the Servo Drives and their connection targets are as follows.

Model	Number of ⊕ terminals	Connection to
R88D-1SN01L-ECT/-1SN02L-ECT/-1SN04L-ECT/ -1SN01H-ECT/-1SN02H-ECT/-1SN04H-ECT/ -1SN08H-ECT/-1SN10H-ECT	1 on top	PE wire of the main circuit power supply cable. FG wire inside the control panel, and FG wire for the motor cable and shielded wire.
	2 on front	
	1 on bottom	
R88D-1SN15H-ECT/-1SN20H-ECT/-1SN30H-ECT/ -1SN06F-ECT/-1SN10F-ECT/-1SN15F-ECT/ -1SN20F-ECT/-1SN30F-ECT	1 on top	PE wire of the main circuit power supply cable. FG wire inside the control panel and the motor cable shielded wire.
	2 on front	
	1 on bottom	

Dimensions

Single-phase 100 VAC: R88D-1SN01L-ECT (100 W)

Single-phase/3-phase 200 VAC: R88D-1SN01H-ECT/-1SN02H-ECT (100 to 200 W)

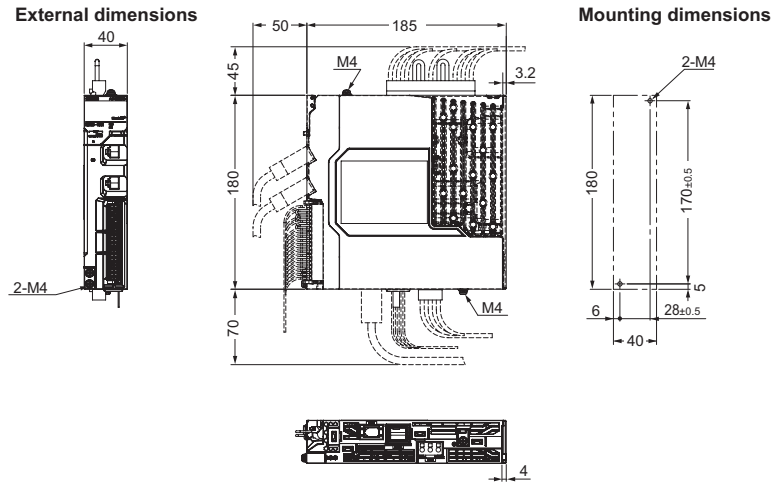

Single-phase 100 VAC: R88D-1SN02L-ECT (200 W)

Single-phase/3-phase 200 VAC: R88D-1SN04H-ECT (400 W)

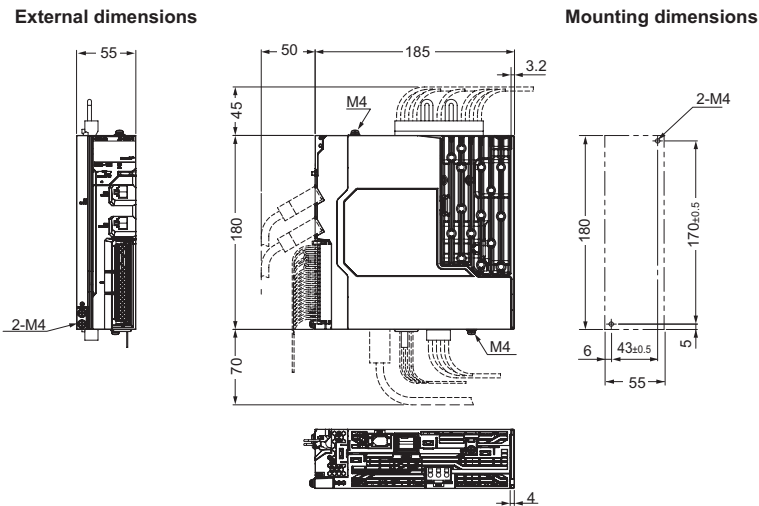

Single-phase 100 VAC: R88D-1SN04L-ECT (400 W)

Single-phase/3-phase 200 VAC: R88D-1SN08H-ECT (750 W)

3-phase 200 VAC: R88D-1SN10H-ECT (1 kW)

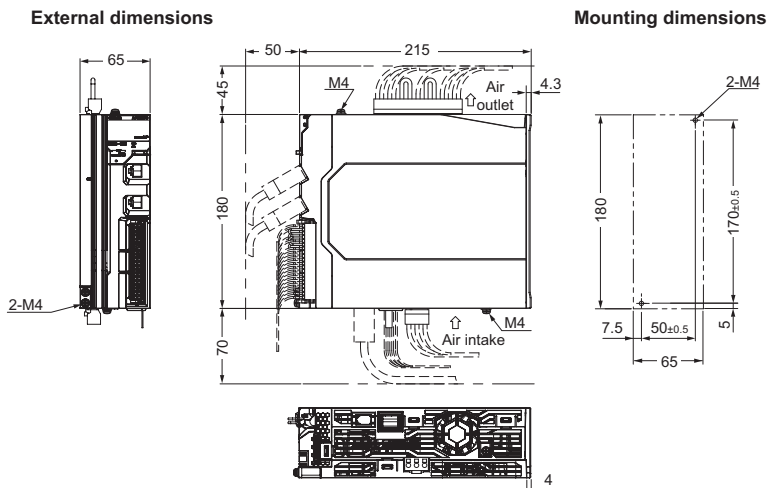

AC Servo System 1S-series

Single-phase/3-phase 200 VAC: R88D-1SN15H-ECT (1.5 kW)

3-phase 200 VAC: R88D-1SN20H-ECT/-1SN30H-ECT (2 to 3 kW)

3-phase 400 VAC: R88D-1SN06F-ECT/-1SN10F-ECT/-1SN15F-ECT/-1SN20F-ECT/-1SN30F-ECT (600 W to 3 kW)

External dimensions

Mounting dimensions

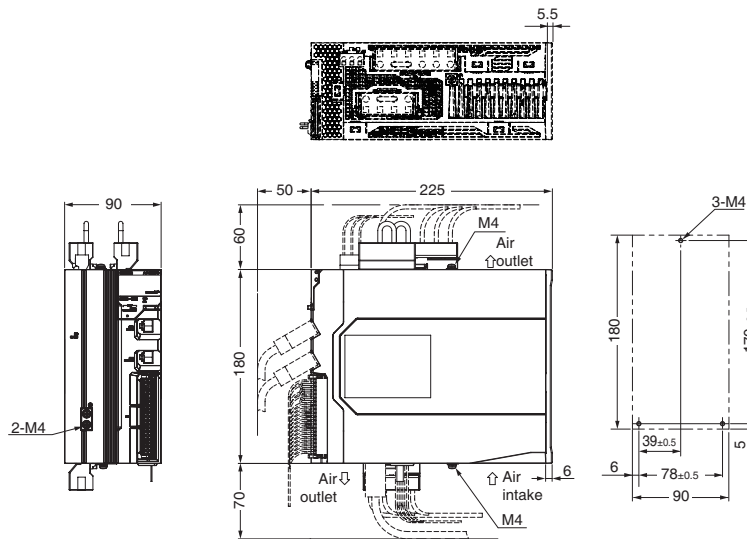

Contents

- Ordering Information
- Specifications
- Names and Functions
- External Dimensions



Ordering Information

Refer to the Ordering Information.

Specifications

General Specifications

Item	Specifications		
Operating ambient temperature and humidity	0 to 40°C 20% to 90% (with no condensation)		
Storage ambient temperature and humidity	-20 to 65°C 20% to 90% (with no condensation)		
Operating and storage atmosphere	No corrosive gases		
Vibration resistance *	Acceleration of 49 m/s ² 24.5 m/s ² max. in X, Y, and Z directions when the motor is stopped		
Impact resistance	Acceleration of 98 m/s ² max. 3 times each in X, Y, and Z directions		
Insulation resistance	Between power terminals and FG terminals: 10 MΩ min. (at 500 VDC Megger)		
Dielectric strength	Between power terminals and FG terminals: 1,500 VAC for 1 min (voltage 100 V, 200 V) Between power terminals and FG terminals: 1,800 VAC for 1 min (voltage 400 V) Between brake terminal and FG terminals: 1,000 VAC for 1 min		
Insulation class	Class F		
Protective structure	IP67 (except for the through-shaft part and connector pins) IP20 if you use a 30-meter or longer encoder cable.		
International standard	EU Directives	Low Voltage Directive	EN 60034-1/-5
	UL standards		UL 1004-1/-6
	CSA standards		CSA C22.2 No.100 (with cUL mark)

* The amplitude may be increased by machine resonance. As a guideline, 80% of the specified value must not be exceeded.

Note: 1. Do not use the cable when it is laying in oil or water.

2. Do not expose the cable outlet or connections to stress due to bending or its own weight.

Encoder Specifications

Item	Specifications
Encoder system	Optical batteryless absolute encoder
Resolution per rotation	23 bits
Multi-rotation data hold	16 bits
Power supply voltage	5 VDC±10%
Current consumption	230 mA max.
Output signal	Serial communications
Output interface	RS485 compliant

Note: It is possible to use an absolute encoder as an incremental encoder.

Refer to the *AC Servomotors/Servo Drives 1S-series with Built-in EtherCAT® Communications User's Manual* (Cat.No.I586) for details.

Characteristics

3,000-r/min Servomotors

Item		Model (R88M-) Unit	100 VAC		
			1M10030S	1M20030S	1M40030S
Rated output *1 *2		W	100	200	400
Rated torque *1 *2		N·m	0.318	0.637	1.27
Rated rotation speed *1 *2		r/min	3,000		
Maximum rotation speed		r/min	6,000		
Momentary maximum torque *1		N·m	0.95	1.91	3.8
Rated current *1 *2		A (rms)	1.50	2.50	4.8
Momentary maximum current *1		A (rms)	4.70	8.40	14.7
Rotor inertia	Without brake	$\times 10^{-4}$ kg·m ²	0.0890	0.2232	0.4452
	With brake	$\times 10^{-4}$ kg·m ²	0.0968	0.2832	0.5052
Applicable load inertia		$\times 10^{-4}$ kg·m ²	1.62	4.80	8.40
Torque constant *1		N·m/ A (rms)	0.24	0.28	0.30
Power rate *1 *3		kW/s	11.9	18.5	36.6
Mechanical time constant *3		ms	1.1	0.76	0.61
Electrical time constant		ms	0.84	2.4	2.4
Allowable radial load *4		N	68	245	245
Allowable thrust load *4		N	58	88	88
Weight	Without brake	kg	0.52	1.0	1.4
	With brake	kg	0.77	1.3	1.9
Radiator plate dimensions (material)		mm	250 × 250 × t6 (aluminum)		
Brake specifications	Excitation voltage *5	V	24 VDC±10%		
	Current consumption (at 20°C)	A	0.27	0.32	0.32
	Static friction torque	N·m	0.32 min.	1.37 min.	1.37 min.
	Attraction time	ms	25 max.	30 max.	30 max.
	Release time *6	ms	15 max.	20 max.	20 max.
	Backlash	°	1.2 max.	1.2 max.	1.2 max.
	Allowable braking work	J	9	60	60
	Allowable total work	J	9,000	60,000	60,000
	Allowable angular acceleration	rad/s ²	10,000 max.		
	Brake lifetime (acceleration/ deceleration)	---	10 million times min.		
Insulation class		---	Class F		

For models with an oil seal, the following derating is used due to increase in friction torque.

Item	Model (R88M-)	1M10030S-O/ -OS2/ -BO/ -BOS2	1M20030S-O/ -OS2/ -BO/ -BOS2	1M40030S-O/ -OS2/ -BO/ -BOS2
	Unit			
Derating rate	%	95	95	80
Rated output	W	95	190	320
Rated current	A (rms)	1.50	2.50	4.0

AC Servo System 1S-series

Item		Model (R88M-) Unit	200 VAC			
			1M10030T	1M20030T	1M40030T	1M75030T
Rated output *1 *2		W	100	200	400	750
Rated torque *1 *2		N-m	0.318	0.637	1.27	2.39
Rated rotation speed *1 *2		r/min	3,000			
Maximum rotation speed		r/min	6,000			
Momentary maximum torque *1		N-m	1.11	2.2	4.5	8.4
Rated current *1 *2		A (rms)	0.84	1.5	2.5	4.6
Momentary maximum current *1		A (rms)	3.10	5.6	9.1	16.9
Rotor inertia	Without brake	$\times 10^{-4}$ kg·m ²	0.0890	0.2232	0.4452	1.8242
	With brake	$\times 10^{-4}$ kg·m ²	0.0968	0.2832	0.5052	2.0742
Applicable load inertia		$\times 10^{-4}$ kg·m ²	1.62	4.80	8.40	19.4
Torque constant *1		N-m/ A (rms)	0.42	0.48	0.56	0.59
Power rate *1 *3		kW/s	11.9	18.5	36.6	31.4
Mechanical time constant *3		ms	1.2	0.78	0.56	0.66
Electrical time constant		ms	0.83	2.4	2.6	3.3
Allowable radial load *4		N	68	245	245	490
Allowable thrust load *4		N	58	88	88	196
Weight	Without brake	kg	0.52	1.0	1.4	2.9
	With brake	kg	0.77	1.3	1.9	3.9
Radiator plate dimensions (material)		mm	250 × 250 × t6 (aluminum)			
Brake specifications	Excitation voltage *5	V	24 VDC \pm 10%			
	Current consumption (at 20°C)	A	0.27	0.32	0.32	0.37
	Static friction torque	N-m	0.32 min.	1.37 min.	1.37 min.	2.55 min.
	Attraction time	ms	25 max.	30 max.	30 max.	40 max.
	Release time *6	ms	15 max.	20 max.	20 max.	35 max.
	Backlash	°	1.2 max.	1.2 max.	1.2 max.	1.0 max.
	Allowable braking work	J	9	60	60	250
	Allowable total work	J	9,000	60,000	60,000	250,000
	Allowable angular acceleration	rad/s ²	10,000 max.			
	Brake lifetime (acceleration/ deceleration)	---	10 million times min.			
	Insulation class	---	Class F			

For models with an oil seal, the following derating is used due to increase in friction torque.

Item	Model (R88M-) Unit	1M10030T-O/ -OS2/ -BO/ -BOS2	1M20030T-O/ -OS2/ -BO/ -BOS2	1M40030T-O/ -OS2/ -BO/ -BOS2	1M75030T-O/ -OS2/ -BO/ -BOS2
		Derating rate	%	95	95
Rated output	W	95	190	320	675
Rated current	A (rms)	0.84	1.5	2.1	4.2

AC Servo System 1S-series

Item		Model (R88M-)	200 VAC			
			1L1K030T	1L1K530T	1L2K030T	1L3K030T
Rated output *1 *2		W	1,000	1,500	2,000	3,000
Rated torque *1 *2		N·m	3.18	4.77	6.37	9.55
Rated rotation speed *1 *2		r/min	3,000			
Maximum rotation speed		r/min	5,000			
Momentary maximum torque *1		N·m	9.55	14.3	19.1	28.7
Rated current *1 *2		A (rms)	5.2	8.8	12.5	17.1
Momentary maximum current *1		A (rms)	16.9	28.4	41.0	54.7
Rotor inertia	Without brake	× 10 ⁻⁴ kg·m ²	2.1042	2.1042	2.4042	6.8122
	With brake	× 10 ⁻⁴ kg·m ²	2.5542	2.5542	2.8542	7.3122
Applicable load inertia		× 10 ⁻⁴ kg·m ²	35.3	47.6	60.2	118
Torque constant *1		N·m/ A (rms)	0.67	0.58	0.56	0.64
Power rate *1 *3		kW/s	48	108	169	134
Mechanical time constant *3		ms	0.58	0.58	0.50	0.47
Electrical time constant		ms	5.9	6.1	6.4	11
Allowable radial load *4		N	490			
Allowable thrust load *4		N	196			
Weight	Without brake	kg	5.7	5.7	6.4	11.5
	With brake	kg	7.4	7.4	8.1	12.5
Radiator plate dimensions (material)		mm	400 × 400 × t20 (aluminum)		470 × 470 × t20 (aluminum)	
Brake specifications	Excitation voltage *5	V	24 VDC±10%			
	Current consumption (at 20°C)	A	0.70	0.70	0.70	0.66
	Static friction torque	N·m	9.3 min.	9.3 min.	9.3 min.	12.0 min.
	Attraction time	ms	100 max.	100 max.	100 max.	100 max.
	Release time *6	ms	30 max.	30 max.	30 max.	30 max.
	Backlash	°	1.0 max.	1.0 max.	1.0 max.	0.8 max.
	Allowable braking work	J	500	500	500	1,000
	Allowable total work	J	900,000	900,000	900,000	3,000,000
	Allowable angular acceleration	rad/s ²	10,000 max.			
	Brake lifetime (acceleration/ deceleration)	---	10 million times min.			
Insulation class		---	Class F			

AC Servo System 1S-series

Item		Model (R88M-) Unit	400 VAC		
			1L75030C	1L1K030C	1L1K530C
Rated output *1 *2		W	750	1,000	1,500
Rated torque *1 *2		N·m	2.39	3.18	4.77
Rated rotation speed *1 *2		r/min	3,000		
Maximum rotation speed		r/min	5,000		
Momentary maximum torque *1		N·m	7.16	9.55	14.3
Rated current *1 *2		A (rms)	3.0	3.0	4.5
Momentary maximum current *1		A (rms)	9.6	9.6	14.1
Rotor inertia	Without brake	$\times 10^{-4}$ kg·m ²	1.3042	2.1042	2.1042
	With brake	$\times 10^{-4}$ kg·m ²	1.7542	2.5542	2.5542
Applicable load inertia		$\times 10^{-4}$ kg·m ²	38.6	35.3	47.6
Torque constant *1		N·m/ A (rms)	0.91	1.17	1.17
Power rate *1 *3		kW/s	44	48	108
Mechanical time constant *3		ms	1.09	0.6	0.58
Electrical time constant		ms	4.3	5.9	5.9
Allowable radial load *4		N	490		
Allowable thrust load *4		N	196		
Weight	Without brake	kg	4.1	5.7	5.7
	With brake	kg	5.8	7.4	7.4
Radiator plate dimensions (material)		mm	305 × 305 × t20 (aluminum)	400 × 400 × t20 (aluminum)	
Brake specifications	Excitation voltage *5	V	24 VDC \pm 10%		
	Current consumption (at 20°C)	A	0.70	0.70	0.70
	Static friction torque	N·m	9.3 min.	9.3 min.	9.3 min.
	Attraction time	ms	100 max.	100 max.	100 max.
	Release time *6	ms	30 max.	30 max.	30 max.
	Backlash	°	1.0 max.	1.0 max.	1.0 max.
	Allowable braking work	J	500	500	500
	Allowable total work	J	900,000	900,000	900,000
	Allowable angular acceleration	rad/s ²	10,000 max.		
	Brake lifetime (acceleration/ deceleration)	---	10 million times min.		
Insulation class		---	Class F		

Item		Model (R88M-)	400 VAC	
			1L2K030C	1L3K030C
Rated output *1 *2		W	2,000	3,000
Rated torque *1 *2		N·m	6.37	9.55
Rated rotation speed *1 *2		r/min	3,000	
Maximum rotation speed		r/min	5,000	
Momentary maximum torque *1		N·m	19.1	28.7
Rated current *1 *2		A (rms)	6.3	8.7
Momentary maximum current *1		A (rms)	19.8	27.7
Rotor inertia	Without brake	$\times 10^{-4}$ kg·m ²	2.4042	6.8122
	With brake	$\times 10^{-4}$ kg·m ²	2.8542	7.3122
Applicable load inertia		$\times 10^{-4}$ kg·m ²	60.2	118
Torque constant *1		N·m/ A (rms)	1.15	1.23
Power rate *1 *3		kW/s	169	134
Mechanical time constant *3		ms	0.52	0.49
Electrical time constant		ms	6.3	11
Allowable radial load *4		N	490	
Allowable thrust load *4		N	196	
Weight	Without brake	kg	6.4	11.5
	With brake	kg	8.1	12.5
Radiator plate dimensions (material)		mm	470 × 470 × t20 (aluminum)	
Brake specifications	Excitation voltage *5	V	24 VDC \pm 10%	
	Current consumption (at 20°C)	A	0.70	0.66
	Static friction torque	N·m	9.3 min.	12 min.
	Attraction time	ms	100 max.	100 max.
	Release time *6	ms	30 max.	30 max.
	Backlash	°	1.0 max.	0.8 max.
	Allowable braking work	J	500	1,000
	Allowable total work	J	900,000	3,000,000
	Allowable angular acceleration	rad/s ²	10,000 max.	
	Brake lifetime (acceleration/ deceleration)	---	10 million times min.	
	Insulation class	---	Class F	

*1. This is a typical value for when the Servomotor is used at a normal temperature (20°C, 65%) in combination with a Servo Drive.

*2. The rated values are the values with which continuous operation is possible at an ambient temperature of 40°C when the Servomotor is horizontally installed on a specified radiator plate.

*3. This value is for models without options.

*4. The allowable radial and thrust loads are the values determined for a limit of 20,000 hours at normal operating temperatures. The allowable radial loads are applied as shown in the following diagram.

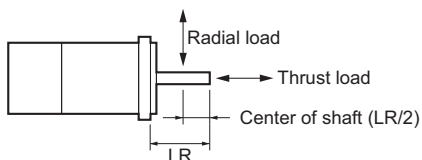

*5. This is a non-excitation brake. It is released when excitation voltage is applied.

*6. This value is a reference value.

AC Servo System 1S-series

Torque-Rotation Speed Characteristics for 3,000-r/min Servomotors (100 VAC)

The following graphs show the characteristics with a 3-m standard cable and a 100 VAC input.

• R88M-1M10030S

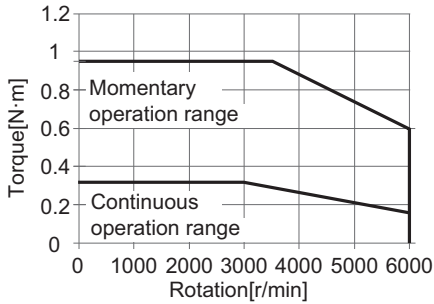

• R88M-1M20030S

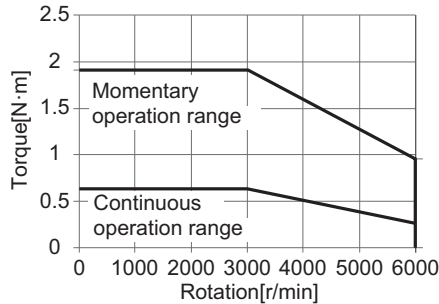

• R88M-1M40030S

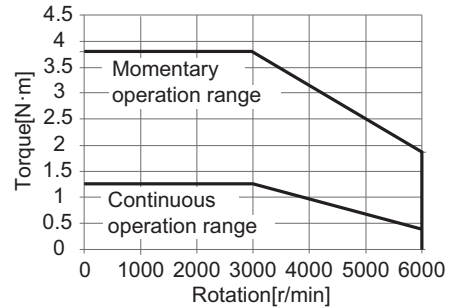

Note: The continuous operation range is the range in which continuous operation is possible at an ambient temperature of 40°C when the Servomotor is horizontally installed on a specified radiator plate. Continuous operation at the maximum speed is also possible. However, doing so will reduce the output torque.

Torque-Rotation Speed Characteristics for 3,000-r/min Servomotors (200 VAC)

The following graphs show the characteristics with a 3-m standard cable and a 3-phase 200-VAC or single-phase 220-VAC input.

• R88M-1M10030T

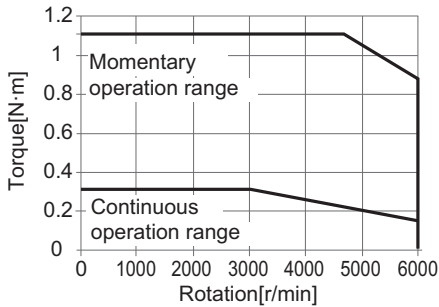

• R88M-1M20030T

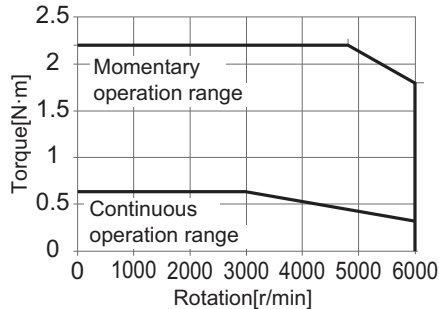

• R88M-1M40030T

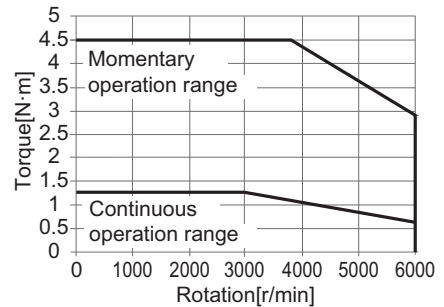

• R88M-1M75030T

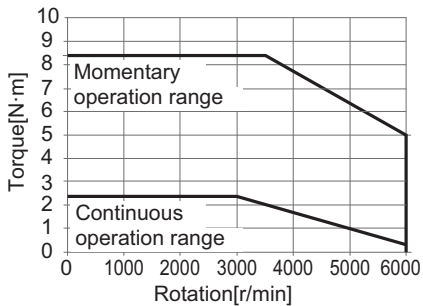

• R88M-1L1K030T

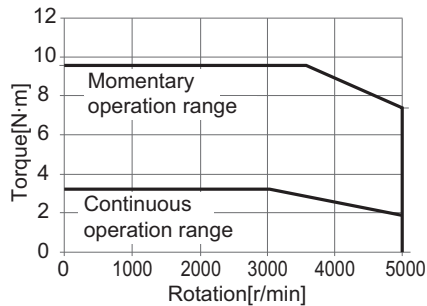

• R88M-1L1K530T

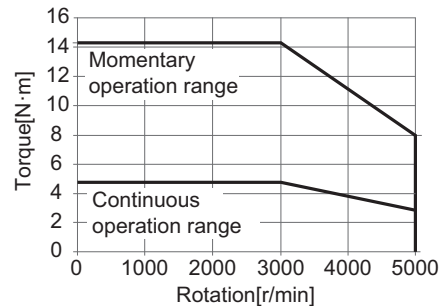

• R88M-1L2K030T

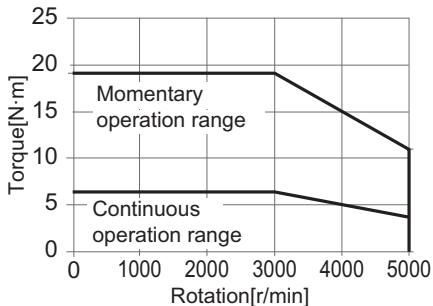

• R88M-1L3K030T

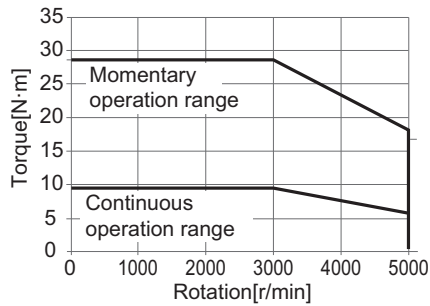

Note: The continuous operation range is the range in which continuous operation is possible at an ambient temperature of 40°C when the Servomotor is horizontally installed on a specified radiator plate. Continuous operation at the maximum speed is also possible. However, doing so will reduce the output torque.

Torque-Rotation Speed Characteristics for 3,000-r/min Servomotors (400 VAC)

The following graphs show the characteristics with a 3-m standard cable and a 400 VAC input.

• R88M-1L75030C

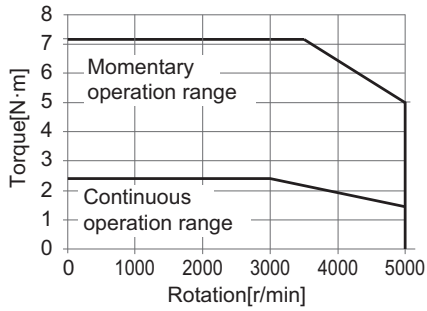

• R88M-1L1K030C

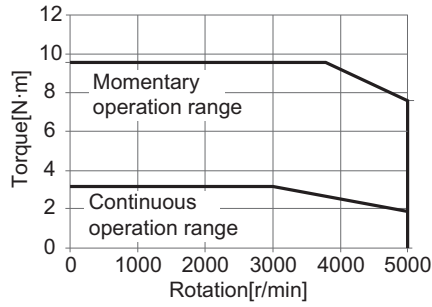

• R88M-1L1K530C

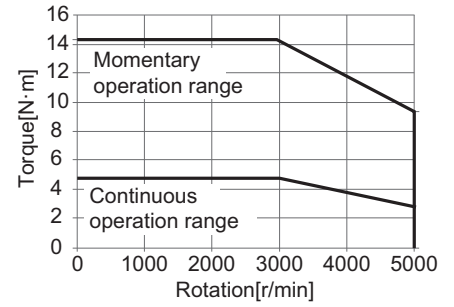

• R88M-1L2K030C

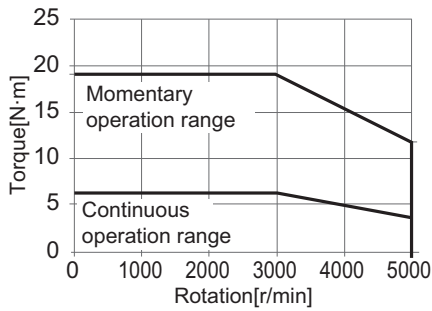

• R88M-1L3K030C

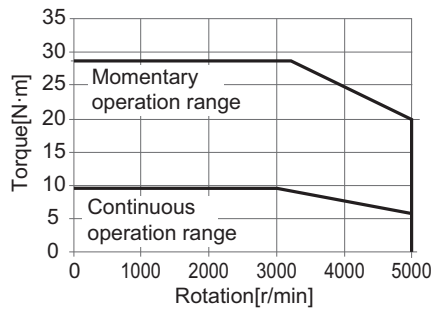

Note: The continuous operation range is the range in which continuous operation is possible at an ambient temperature of 40°C when the Servomotor is horizontally installed on a specified radiator plate. Continuous operation at the maximum speed is also possible. However, doing so will reduce the output torque.

AC Servo System 1S-series

2,000-r/min Servomotors

Item		Model (R88M-) Unit	200 VAC			
			1M1K020T	1M1K520T	1M2K020T	1M3K020T
Rated output *1 *2		W	1,000	1,500	2,000	3,000
Rated torque *1 *2		N·m	4.77	7.16	9.55	14.3
Rated rotation speed *1 *2		r/min	2,000			
Maximum rotation speed		r/min	3,000			
Momentary maximum torque *1		N·m	14.3	21.5	28.7	43.0
Rated current *1 *2		A (rms)	5.2	8.6	11.3	15.7
Momentary maximum current *1		A (rms)	16.9	28.4	40.6	54.7
Rotor inertia	Without brake	$\times 10^{-4}$ kg·m ²	6.0042	9.0042	12.2042	15.3122
	With brake	$\times 10^{-4}$ kg·m ²	6.5042	9.5042	12.7042	17.4122
Applicable load inertia		$\times 10^{-4}$ kg·m ²	59.0	79.9	100	142
Torque constant *1		N·m/ A (rms)	0.93	0.83	0.85	0.93
Power rate *1 *3		kW/s	38	57	75	134
Mechanical time constant *3		ms	0.94	0.78	0.81	0.80
Electrical time constant		ms	13	15	14	19
Allowable radial load *4		N	490			784
Allowable thrust load *4		N	196			343
Weight	Without brake	kg	6.6	8.5	10	12
	With brake	kg	8.6	10.5	12	15
Radiator plate dimensions (material)		mm	400 × 400 × t20 (aluminum)	470 × 470 × t20 (aluminum)		
Brake specifications	Excitation voltage *5	V	24 VDC±10%			
	Current consumption (at 20°C)	A	0.51	0.51	0.66	0.60
	Static friction torque	N·m	9.0 min.	9.0 min.	12 min.	16 min.
	Attraction time	ms	100 max.	100 max.	100 max.	150 max.
	Release time *6	ms	30 max.	30 max.	30 max.	50 max.
	Backlash	°	0.6 max.	0.6 max.	0.6 max.	0.6 max.
	Allowable braking work	J	1,000	1,000	1,000	350
	Allowable total work	J	3,000,000	3,000,000	3,000,000	1,000,000
	Allowable angular acceleration	rad/s ²	10,000 max.			
	Brake lifetime (acceleration/ deceleration)	---	10 million times min.			
Insulation class		---	Class F			

Item		Model (R88M-) Unit	400 VAC		
			1M40020C	1M60020C	1M1K020C
Rated output *1 *2		W	400	600	1,000
Rated torque *1 *2		N·m	1.91	2.86	4.77
Rated rotation speed *1 *2		r/min	2,000		
Maximum rotation speed		r/min	3,000		
Momentary maximum torque *1		N·m	5.73	8.59	14.3
Rated current *1 *2		A (rms)	1.1	1.6	2.9
Momentary maximum current *1		A (rms)	3.9	5.5	9.4
Rotor inertia	Without brake	$\times 10^{-4}$ kg·m ²	2.5042	3.9042	6.0042
	With brake	$\times 10^{-4}$ kg·m ²	2.8472	4.2472	6.5042
Applicable load inertia		$\times 10^{-4}$ kg·m ²	19.0	23.5	59.0
Torque constant *1		N·m/ A (rms)	1.75	1.84	1.69
Power rate *1 *3		kW/s	14.6	21.0	38
Mechanical time constant *3		ms	1.57	1.21	0.94
Electrical time constant		ms	6.8	7.8	13
Allowable radial load *4		N	490		
Allowable thrust load *4		N	196		
Weight	Without brake	kg	3.9	4.7	6.6
	With brake	kg	4.8	5.8	8.6
Radiator plate dimensions (material)		mm	305 × 305 × t12 (aluminum)		400 × 400 × t20 (aluminum)
Brake specifications	Excitation voltage *5	V	24 VDC±10%		
	Current consumption (at 20°C)	A	0.30	0.30	0.51
	Static friction torque	N·m	3.92 min.	3.92 min.	9.0 min.
	Attraction time	ms	40 max.	40 max.	100 max.
	Release time *6	ms	25 max.	25 max.	30 max.
	Backlash	°	1.0 max.	1.0 max.	0.6 max.
	Allowable braking work	J	330	330	1,000
	Allowable total work	J	330,000	330,000	3,000,000
	Allowable angular acceleration	rad/s ²	10,000 max.		
	Brake lifetime (acceleration/ deceleration)	---	10 million times min.		
Insulation class		---	Class F		

AC Servo System 1S-series

Item		Model (R88M-) Unit	400 VAC		
			1M1K520C	1M2K020C	1M3K020C
Rated output *1 *2		W	1,500	2,000	3,000
Rated torque *1 *2		N·m	7.16	9.55	14.3
Rated rotation speed *1 *2		r/min	2,000		
Maximum rotation speed		r/min	3,000		
Momentary maximum torque *1		N·m	21.5	28.7	43.0
Rated current *1 *2		A (rms)	4.1	5.7	8.6
Momentary maximum current *1		A (rms)	13.5	19.8	28.3
Rotor inertia	Without brake	$\times 10^{-4}$ kg·m ²	9.0042	12.2042	15.3122
	With brake	$\times 10^{-4}$ kg·m ²	9.5042	12.7042	17.4122
Applicable load inertia		$\times 10^{-4}$ kg·m ²	79.9	100	142
Torque constant *1		N·m/ A (rms)	1.75	1.75	1.74
Power rate *1 *3		kW/s	57	75	134
Mechanical time constant *3		ms	0.85	0.80	0.76
Electrical time constant		ms	13	14	20
Allowable radial load *4		N	490		784
Allowable thrust load *4		N	196		343
Weight	Without brake	kg	8.5	10	12
	With brake	kg	10.5	12	15
Radiator plate dimensions (material)		mm	470 × 470 × t20 (aluminum)		
Brake specifications	Excitation voltage *5	V	24 VDC \pm 10%		
	Current consumption (at 20°C)	A	0.51	0.66	0.60
	Static friction torque	N·m	9.0 min.	12 min.	16 min.
	Attraction time	ms	100 max.	100 max.	150 max.
	Release time *6	ms	30 max.	30 max.	50 max.
	Backlash	°	0.6 max.	0.6 max.	0.6 max.
	Allowable braking work	J	1,000	1,000	350
	Allowable total work	J	3,000,000	3,000,000	1,000,000
	Allowable angular acceleration	rad/s ²	10,000 max.		
	Brake lifetime (acceleration/ deceleration)	---	10 million times min.		
	Insulation class	---	Class F		

*1. This is a typical value for when the Servomotor is used at a normal temperature (20°C, 65%) in combination with a Servo Drive.

*2. The rated values are the values with which continuous operation is possible at an ambient temperature of 40°C when the Servomotor is horizontally installed on a specified radiator plate.

*3. This value is for models without options.

*4. The allowable radial and thrust loads are the values determined for a limit of 20,000 hours at normal operating temperatures. The allowable radial loads are applied as shown in the following diagram.

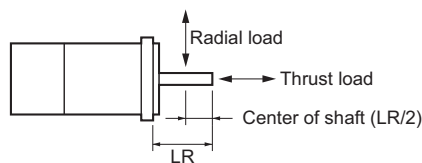

*5. This is a non-excitation brake. It is released when excitation voltage is applied.

*6. This value is a reference value.

Torque-Rotation Speed Characteristics for 2,000-r/min Servomotors (200 VAC)

The following graphs show the characteristics with a 3-m standard cable and a 3-phase 200-VAC or single-phase 220-VAC input.

• R88M-1M1K020T

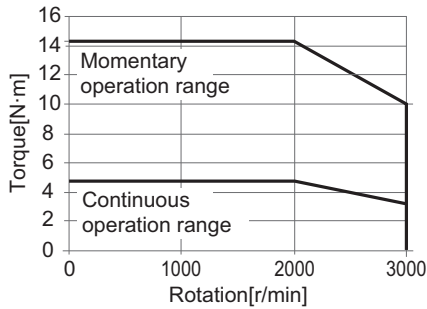

• R88M-1M1K520T

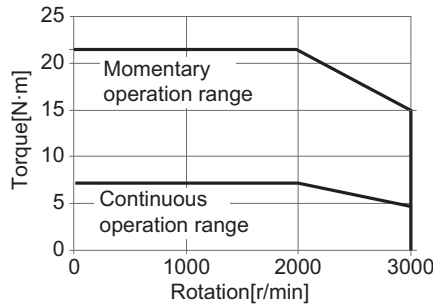

• R88M-1M2K020T

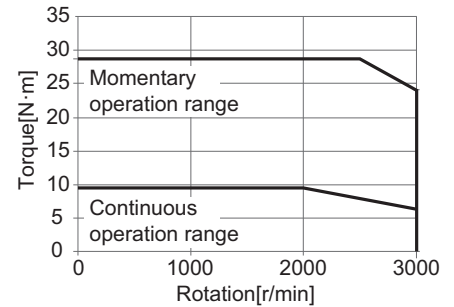

• R88M-1M3K020T

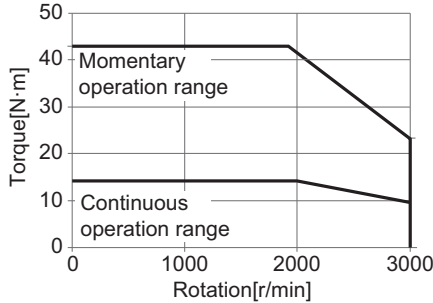

Note: The continuous operation range is the range in which continuous operation is possible at an ambient temperature of 40°C when the Servomotor is horizontally installed on a specified radiator plate. Continuous operation at the maximum speed is also possible. However, doing so will reduce the output torque.

Torque-Rotation Speed Characteristics for 2,000-r/min Servomotors (400 VAC)

The following graphs show the characteristics with a 3-m standard cable and a 400 VAC input.

• R88M-1M40020C

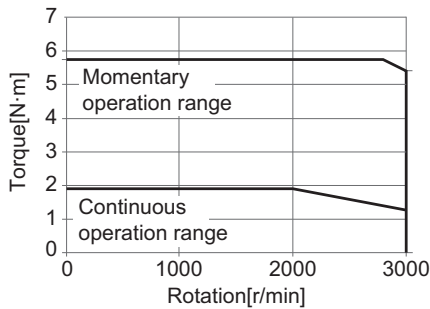

• R88M-1M60020C

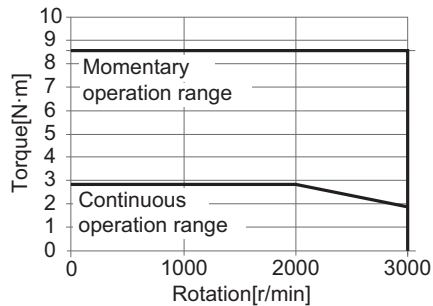

• R88M-1M1K020C

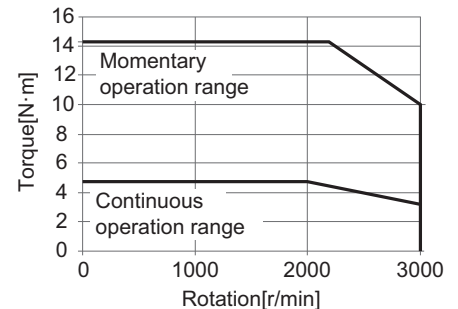

• R88M-1M1K520C

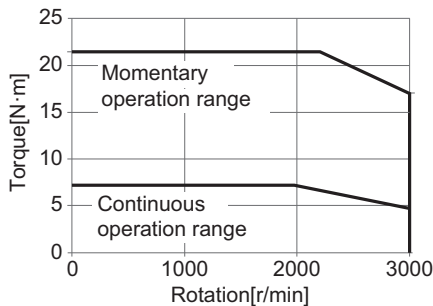

• R88M-1M2K020C

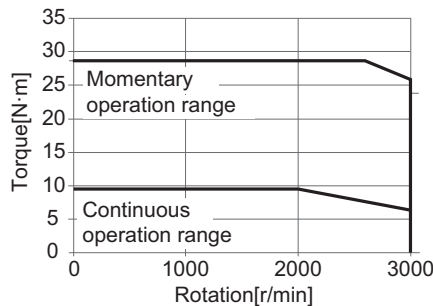

• R88M-1M3K020C

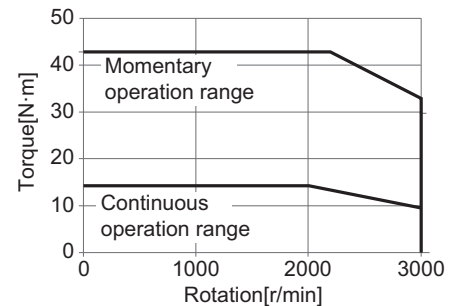

Note: The continuous operation range is the range in which continuous operation is possible at an ambient temperature of 40°C when the Servomotor is horizontally installed on a specified radiator plate. Continuous operation at the maximum speed is also possible. However, doing so will reduce the output torque.

AC Servo System 1S-series

1,000-r/min Servomotors

Item		Model (R88M-) Unit	200 VAC		
			1M90010T	1M2K010T	1M3K010T
Rated output *1 *2		W	900	2,000	3,000
Rated torque *1 *2		N·m	8.59	19.1	28.7
Rated rotation speed *1 *2		r/min	1,000		
Maximum rotation speed		r/min	2,000		
Momentary maximum torque *1		N·m	19.3	47.7	71.7
Rated current *1 *2		A (rms)	6.7	14.4	21.2
Momentary maximum current *1		A (rms)	16.9	40.6	54.7
Rotor inertia	Without brake	$\times 10^{-4}$ kg·m ²	9.0042	40.0122	68.0122
	With brake	$\times 10^{-4}$ kg·m ²	9.5042	45.1122	73.1122
Applicable load inertia		$\times 10^{-4}$ kg·m ²	79.9	314	492
Torque constant *1		N·m/ A (rms)	1.28	1.45	1.51
Power rate *1 *3		kW/s	82	91	121
Mechanical time constant *3		ms	0.77	1.0	0.83
Electrical time constant		ms	15	18	22
Allowable radial load *4		N	686	1,176	1,470
Allowable thrust load *4		N	196	490	
Weight	Without brake	kg	8.5	18	28
	With brake	kg	10.5	22	33
Radiator plate dimensions (material)		mm	470 × 470 × t20 (aluminum)		540 × 540 × t20 (aluminum)
Brake specifications	Excitation voltage *5	V	24 VDC±10%		
	Current consumption (at 20°C)	A	0.51	1.2	1.0
	Static friction torque	N·m	9.0 min.	22 min.	42 min.
	Attraction time	ms	100 max.	120 max.	150 max.
	Release time *6	ms	30 max.	50 max.	60 max.
	Backlash	°	0.6 max.	0.8 max.	0.8 max.
	Allowable braking work	J	1,000	1,400	1,400
	Allowable total work	J	3,000,000	4,600,000	4,600,000
	Allowable angular acceleration	rad/s ²	10,000 max.		
	Brake lifetime (acceleration/ deceleration)	---	10 million times min.		
	Insulation class	---	Class F		

Item		Model (R88M-)	400 VAC		
			1M90010C	1M2K010C	1M3K010C
Rated output *1 *2		W	900	2,000	3,000
Rated torque *1 *2		N·m	8.59	19.1	28.7
Rated rotation speed *1 *2		r/min	1,000		
Maximum rotation speed		r/min	2,000		
Momentary maximum torque *1		N·m	19.3	47.7	71.7
Rated current *1 *2		A (rms)	3.6	7.1	10.6
Momentary maximum current *1		A (rms)	9.0	19.5	27.7
Rotor inertia	Without brake	$\times 10^{-4}$ kg·m ²	9.0042	40.0122	68.0122
	With brake	$\times 10^{-4}$ kg·m ²	9.5042	45.1122	73.1122
Applicable load inertia		$\times 10^{-4}$ kg·m ²	79.9	314	492
Torque constant *1		N·m/ A (rms)	2.41	3.00	2.97
Power rate *1 *3		kW/s	82	91	121
Mechanical time constant *3		ms	0.88	1.2	0.92
Electrical time constant		ms	13	16	19
Allowable radial load *4		N	686	1,176	1,470
Allowable thrust load *4		N	196	490	
Weight	Without brake	kg	8.5	18	28
	With brake	kg	10.5	22	33
Radiator plate dimensions (material)		mm	470 × 470 × t20 (aluminum)		540 × 540 × t20 (aluminum)
Brake specifications	Excitation voltage *5	V	24 VDC \pm 10%		
	Current consumption (at 20°C)	A	0.51	1.2	1.0
	Static friction torque	N·m	9.0 min.	22 min.	42 min.
	Attraction time	ms	100 max.	120 max.	150 max.
	Release time *6	ms	30 max.	50 max.	60 max.
	Backlash	°	0.6 max.	0.8 max.	0.8 max.
	Allowable braking work	J	1,000	1,400	1,400
	Allowable total work	J	3,000,000	4,600,000	4,600,000
	Allowable angular acceleration	rad/s ²	10,000 max.		
	Brake lifetime (acceleration/ deceleration)	---	10 million times min.		
Insulation class		---	Class F		

*1. This is a typical value for when the Servomotor is used at a normal temperature (20°C, 65%) in combination with a Servo Drive.

*2. The rated values are the values with which continuous operation is possible at an ambient temperature of 40°C when the Servomotor is horizontally installed on a specified radiator plate.

*3. This value is for models without options.

*4. The allowable radial and thrust loads are the values determined for a limit of 20,000 hours at normal operating temperatures. The allowable radial loads are applied as shown in the following diagram.

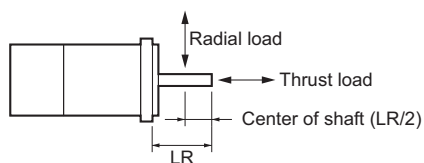

*5. This is a non-excitation brake. It is released when excitation voltage is applied.

*6. This value is a reference value.

AC Servo System 1S-series

Torque-Rotation Speed Characteristics for 1,000-r/min Servomotors (200 V/400 VAC)

The following graphs show the characteristics with a 3-m standard cable and a 3-phase 200-VAC or single-phase 220/400-VAC input.

• R88M-1M90010T

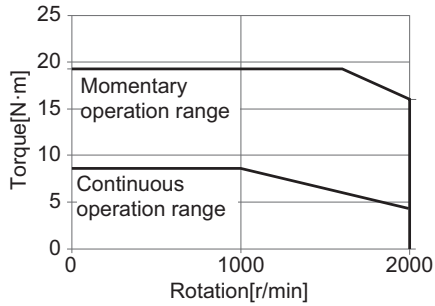

• R88M-1M2K010T

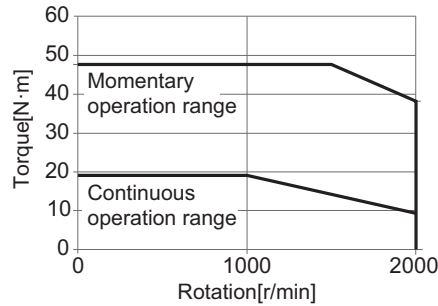

• R88M-1M3K010T

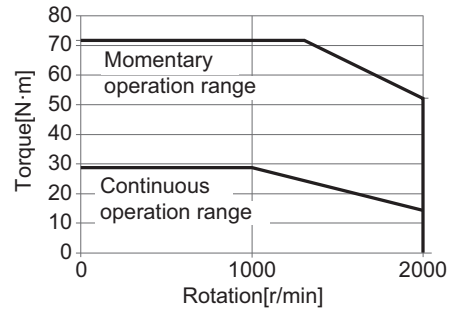

• R88M-1M90010C

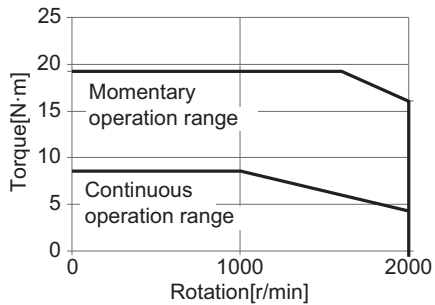

• R88M-1M2K010C

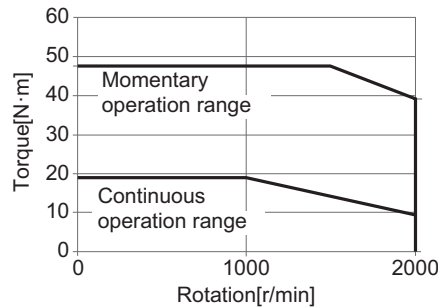

• R88M-1M3K010C

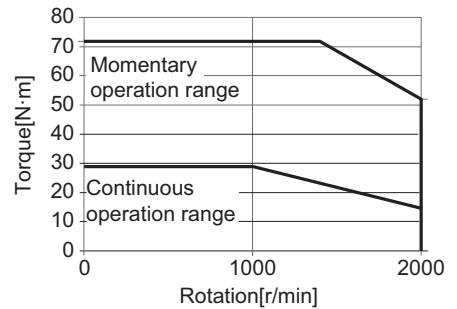

Note: The continuous operation range is the range in which continuous operation is possible at an ambient temperature of 40°C when the Servomotor is horizontally installed on a specified radiator plate. Continuous operation at the maximum speed is also possible. However, doing so will reduce the output torque.

Part Names

Servomotor Part Names

Flange Size of 80 × 80 or less

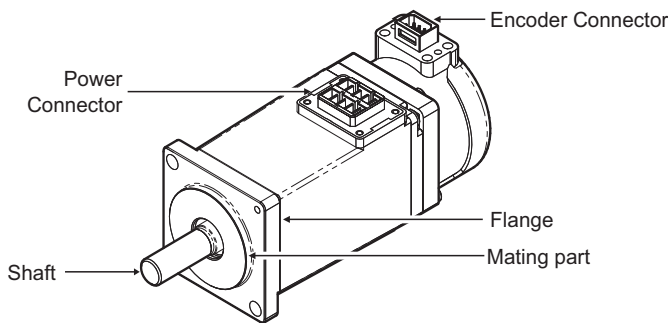

100 VAC 100 W Servomotors (without Brake)

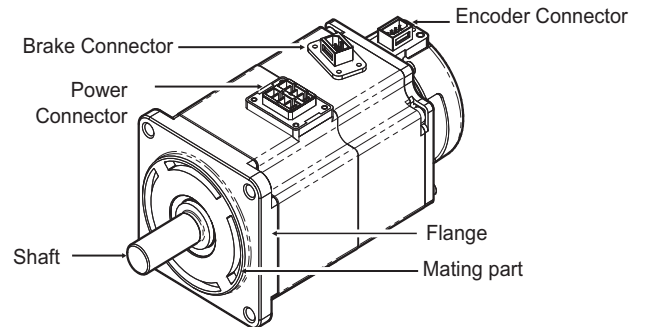

200 VAC 200 W Servomotors (with Brake)

Flange Size of 100 × 100 or more

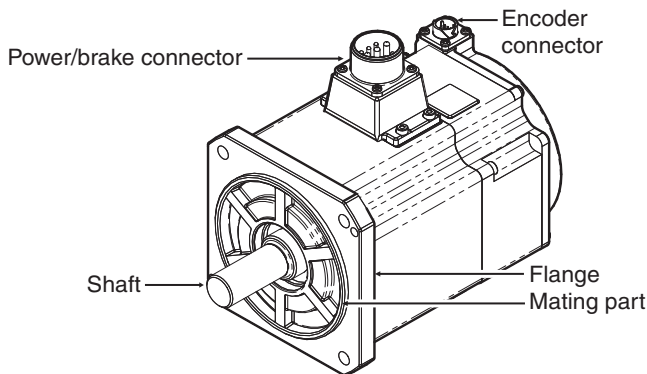

200 VAC 1.5 kW Servomotors (with Brake)

Servomotor Functions

Shaft

The load is mounted on this shaft.

The direction which is in parallel with the shaft is called the thrust direction, and the direction which is perpendicular to the shaft is called the radial direction.

Flange

Used for mounting the Servomotor on the equipment.

Fit the mating part into the equipment and use the mounting holes to screw the Servomotor.

Power Connector

Used for supplying power to the phase U, V, and W of the Servomotor.

For Servomotors with a brake and flange size of 100 × 100 or more, the pins for power and brake are set on the same connector.

Encoder Connector

Used for supplying power to the encoder of the Servomotor and communicating with the Servo Drive.

Brake Connector

Used for supplying power to the brake coil of the Servomotor.

This part is attached only to the Servomotors with a brake and flange size of 80 × 80 or less.

AC Servo System 1S-series

External Dimensions

(Unit: mm)

3,000-r/min Servomotors (100 V and 200 V)

100 W (without Brake)

R88M-1M10030S(-O/-S2/-OS2)

R88M-1M10030T(-O/-S2/-OS2)

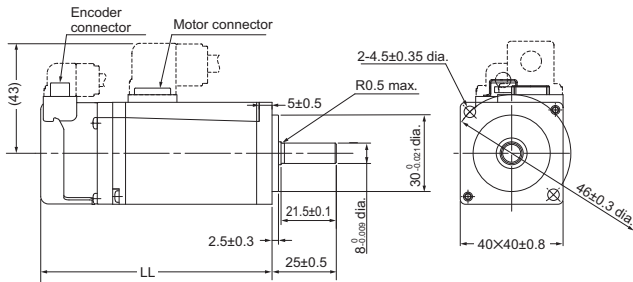

Model	Dimensions [mm]
	LL
R88M-1M10030S(-S2) R88M-1M10030T(-S2)	90±1
R88M-1M10030S(-O/-OS2) R88M-1M10030T(-O/-OS2)	95±1

Note: The standard shaft type is a straight shaft. Models with a key and tap are indicated with "S2" at the end of the model number. Models with an oil seal are indicated with "O" at the end of the model number.

Shaft-end with key and tap

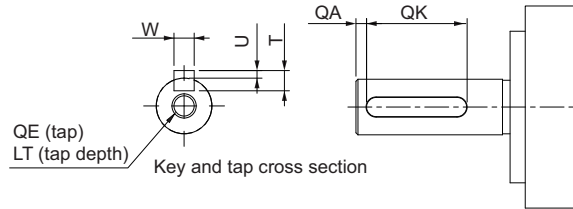

Model	Dimensions [mm]						
	QA	QK	W	T	U	QE	LT
R88M-1M10030S(-S2/-OS2)	2	12	3 ⁰ _{-0.025}	3	1.2 ⁰ _{-0.2}	M3	8
R88M-1M10030T(-S2/-OS2)	2	12	3 ⁰ _{-0.025}	3	1.2 ⁰ _{-0.2}	M3	8

100 W (with Brake)

R88M-1M10030S-B(O/S2/OS2)

R88M-1M10030T-B(O/S2/OS2)

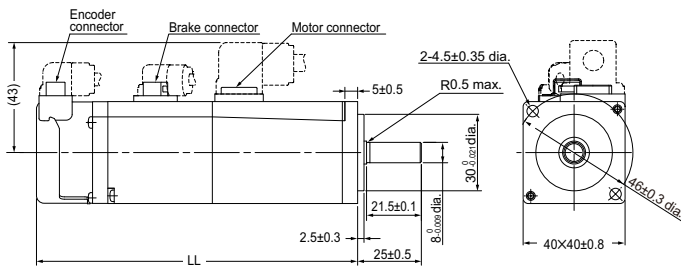

Model	Dimensions [mm]
	LL
R88M-1M10030S-B(S2) R88M-1M10030T-B(S2)	126±1
R88M-1M10030S-B(O/OS2) R88M-1M10030T-B(O/OS2)	131±1

Note: The standard shaft type is a straight shaft. Models with a key and tap are indicated with "S2" at the end of the model number. Models with an oil seal are indicated with "O" at the end of the model number.

Shaft-end with key and tap

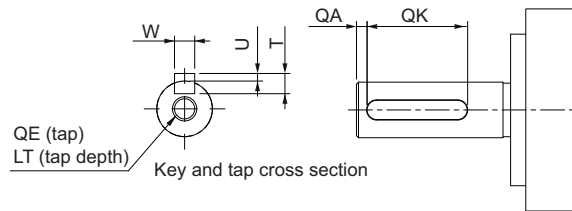

Model	Dimensions [mm]						
	QA	QK	W	T	U	QE	LT
R88M-1M10030S-B(S2/OS2)	2	12	3 ⁰ _{-0.025}	3	1.2 ⁰ _{-0.2}	M3	8
R88M-1M10030T-B(S2/OS2)	2	12	3 ⁰ _{-0.025}	3	1.2 ⁰ _{-0.2}	M3	8

200 W/400 W (without Brake)

R88M-1M20030S(-O/-S2/-OS2)/R88M-1M20030T(-O/-S2/-OS2)
 R88M-1M40030S(-O/-S2/-OS2)/R88M-1M40030T(-O/-S2/-OS2)

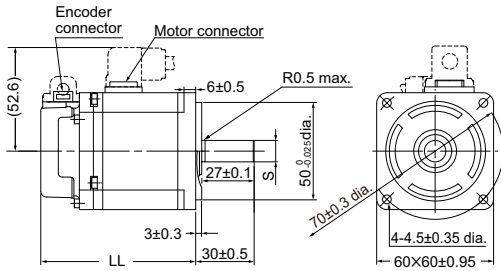

Shaft-end with key and tap

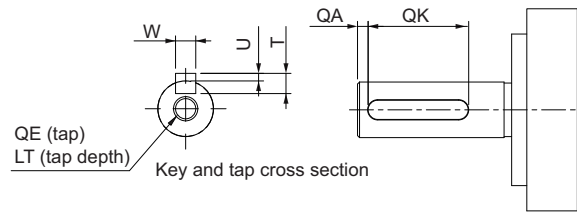

Model	Dimensions [mm]	
	S	LL
R88M-1M20030S(-S2) R88M-1M20030T(-S2)	11 ⁰ _{-0.011} dia.	79.5±1
R88M-1M40030S(-S2) R88M-1M40030T(-S2)	14 ⁰ _{-0.011} dia.	105.5±1
R88M-1M20030S(-O/-OS2) R88M-1M20030T(-O/-OS2)	11 ⁰ _{-0.011} dia.	86.5±1
R88M-1M40030S(-O/-OS2) R88M-1M40030T(-O/-OS2)	14 ⁰ _{-0.011} dia.	112.5±1

Model	Dimensions [mm]						
	QA	QK	W	T	U	QE	LT
R88M-1M20030S(-S2/-OS2)	2	20	4 ⁰ _{-0.03}	4	1.5 ⁰ _{-0.2}	M4	10
R88M-1M20030T(-S2/-OS2)	2	20	4 ⁰ _{-0.03}	4	1.5 ⁰ _{-0.2}	M4	10
R88M-1M40030S(-S2/-OS2)	2	20	5 ⁰ _{-0.03}	5	2 ⁰ _{-0.2}	M5	12
R88M-1M40030T(-S2/-OS2)	2	20	5 ⁰ _{-0.03}	5	2 ⁰ _{-0.2}	M5	12

Note: The standard shaft type is a straight shaft. Models with a key and tap are indicated with "S2" at the end of the model number. Models with an oil seal are indicated with "O" at the end of the model number.

200 W/400 W (with Brake)

R88M-1M20030S-B(O/S2/OS2)/R88M-1M20030T-B(O/S2/OS2)
 R88M-1M40030S-B(O/S2/OS2)/R88M-1M40030T-B(O/S2/OS2)

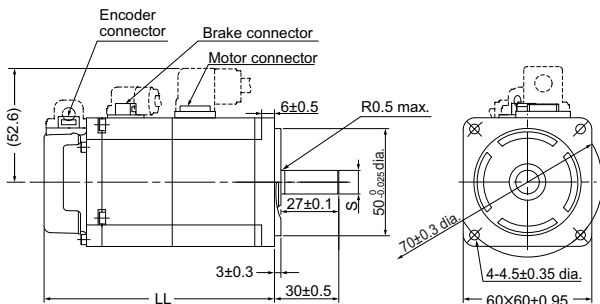

Shaft-end with key and tap

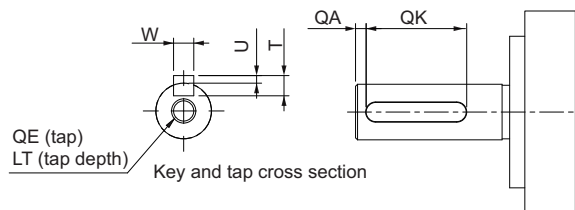

Model	Dimensions [mm]	
	S	LL
R88M-1M20030S-B(S2) R88M-1M20030T-B(S2)	11 ⁰ _{-0.011} dia.	107.5±1
R88M-1M40030S-B(S2) R88M-1M40030T-B(S2)	14 ⁰ _{-0.011} dia.	133.5±1
R88M-1M20030S-B(O/OS2) R88M-1M20030T-B(O/OS2)	11 ⁰ _{-0.011} dia.	114.5±1
R88M-1M40030S-B(O/OS2) R88M-1M40030T-B(O/OS2)	14 ⁰ _{-0.011} dia.	140.5±1

Model	Dimensions [mm]						
	QA	QK	W	T	U	QE	LT
R88M-1M20030S-B(S2/OS2)	2	20	4 ⁰ _{-0.03}	4	1.5 ⁰ _{-0.2}	M4	10
R88M-1M20030T-B(S2/OS2)	2	20	4 ⁰ _{-0.03}	4	1.5 ⁰ _{-0.2}	M4	10
R88M-1M40030S-B(S2/OS2)	2	20	5 ⁰ _{-0.03}	5	2 ⁰ _{-0.2}	M5	12
R88M-1M40030T-B(S2/OS2)	2	20	5 ⁰ _{-0.03}	5	2 ⁰ _{-0.2}	M5	12

Note: The standard shaft type is a straight shaft. Models with a key and tap are indicated with "S2" at the end of the model number. Models with an oil seal are indicated with "O" at the end of the model number.

AC Servo System 1S-series

750 W (without Brake)

R88M-1M75030T(-O/-S2/-OS2)

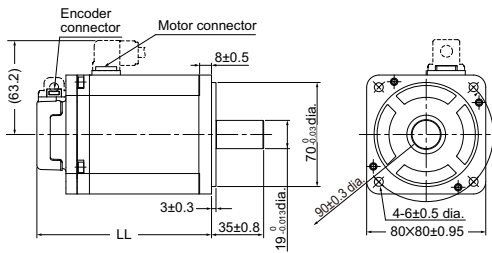

Model	Dimensions [mm]
	LL
R88M-1M75030T(-S2)	117.3±1
R88M-1M75030T(-O/-OS2)	124.3±1

Note: The standard shaft type is a straight shaft. Models with a key and tap are indicated with "S2" at the end of the model number. Models with an oil seal are indicated with "O" at the end of the model number.

Shaft-end with key and tap

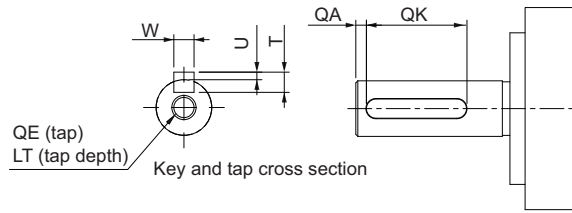

Model	Dimensions [mm]						
	QA	QK	W	T	U	QE	LT
R88M-1M75030T(-S2/-OS2)	3	24	6 ⁰ _{-0.03}	6	2.5 ⁰ _{-0.2}	M5	12

750 W (with Brake)

R88M-1M75030T-B(O/S2/OS2)

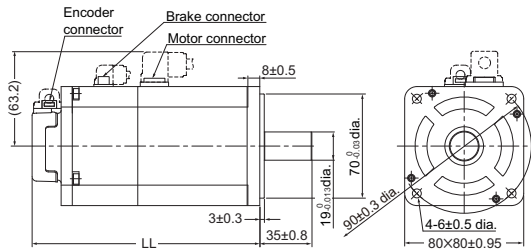

Model	Dimensions [mm]
	LL
R88M-1M75030T-B(S2)	153±1
R88M-1M75030T-B(O/OS2)	160±1

Note: The standard shaft type is a straight shaft. Models with a key and tap are indicated with "S2" at the end of the model number. Models with an oil seal are indicated with "O" at the end of the model number.

Shaft-end with key and tap

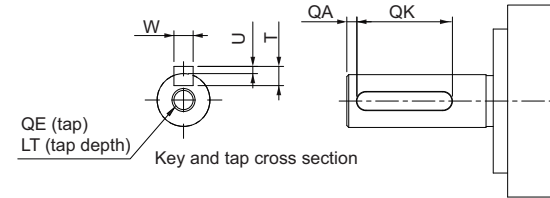

Model	Dimensions [mm]						
	QA	QK	W	T	U	QE	LT
R88M-1M75030T-B(S2/OS2)	3	24	6 ⁰ _{-0.03}	6	2.5 ⁰ _{-0.2}	M5	12

1 kW/1.5 kW/2 kW (without Brake)

R88M-1L1K030T(-O/-S2/-OS2)/R88M-1L1K530T(-O/-S2/-OS2)/R88M-1L2K030T(-O/-S2/-OS2)

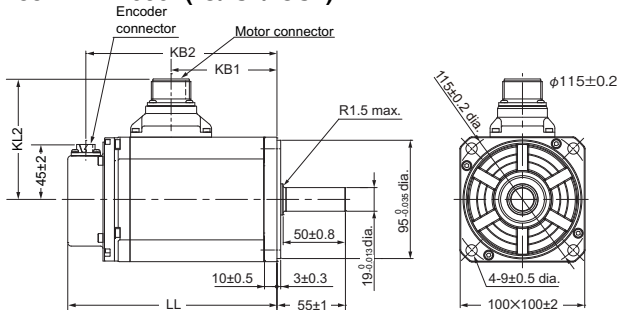

Model	Dimensions [mm]			
	LL	KB1	KB2	KL2
R88M-1L1K030T(-O/-S2/-OS2)	168±2	85±1	153±2	97±2
R88M-1L1K530T(-O/-S2/-OS2)	168±2	85±1	153±2	97±2
R88M-1L2K030T(-O/-S2/-OS2)	179±2	96±1	164±2	102±2

Note: The standard shaft type is a straight shaft. Models with a key and tap are indicated with "S2" at the end of the model number. Models with an oil seal are indicated with "O" at the end of the model number.

Shaft-end with key and tap

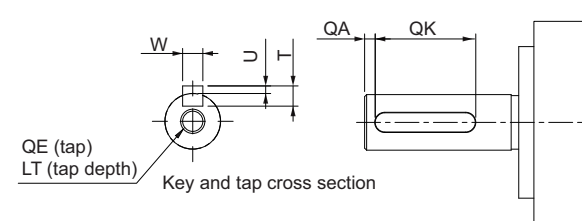

Model	Dimensions [mm]						
	QA	QK	W	T	U	QE	LT
R88M-1L1K030T(-S2/-OS2)	3	42	6 ⁰ _{-0.03}	6	2.5 ⁰ _{-0.2}	M5	12
R88M-1L1K530T(-S2/-OS2)	3	42	6 ⁰ _{-0.03}	6	2.5 ⁰ _{-0.2}	M5	12
R88M-1L2K030T(-S2/-OS2)	3	42	6 ⁰ _{-0.03}	6	2.5 ⁰ _{-0.2}	M5	12

1 kW/1.5 kW/2 kW (with Brake)

R88M-1L1K030T-B(O/S2/OS2)/R88M-1L1K530T-B(O/S2/OS2)/
R88M-1L2K030T-B(O/S2/OS2)

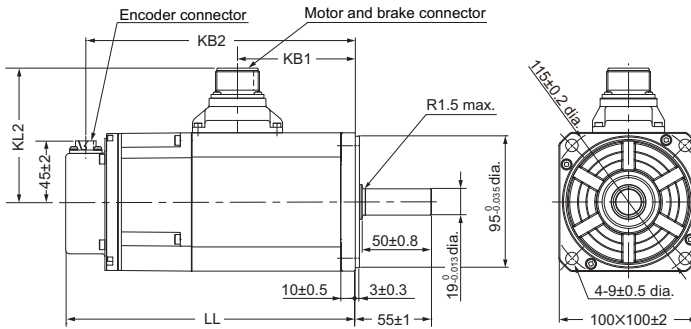

Shaft-end with key and tap

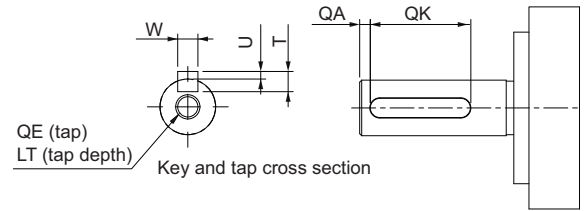

Model	Dimensions [mm]			
	LL	KB1	KB2	KL2
R88M-1L1K030T-B(O/S2/OS2)	209±3	85±1	194±2	97±2
R88M-1L1K530T-B(O/S2/OS2)	209±3	85±1	194±2	97±2
R88M-1L2K030T-B(O/S2/OS)	220±3	96±1	205±2	104±2

Model	Dimensions [mm]						
	QA	QK	W	T	U	QE	LT
R88M-1L1K030T-B(S2/OS2)	3	42	6 ⁰ _{-0.03}	6	2.5 ⁰ _{-0.2}	M5	12
R88M-1L1K530T-B(S2/OS2)	3	42	6 ⁰ _{-0.03}	6	2.5 ⁰ _{-0.2}	M5	12
R88M-1L2K030T-B(S2/OS2)	3	42	6 ⁰ _{-0.03}	6	2.5 ⁰ _{-0.2}	M5	12

Note: The standard shaft type is a straight shaft. Models with a key and tap are indicated with "S2" at the end of the model number. Models with an oil seal are indicated with "O" at the end of the model number.

3 kW (without Brake)

R88M-1L3K030T(O/S2/OS2)

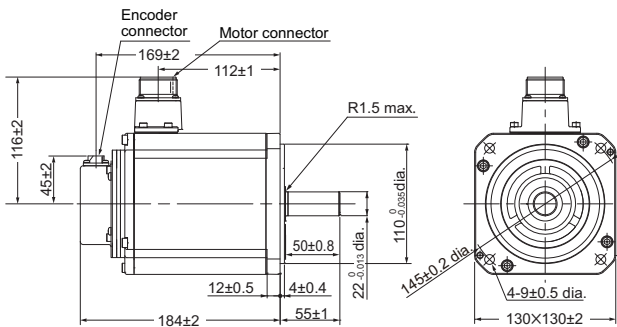

Shaft-end with key and tap

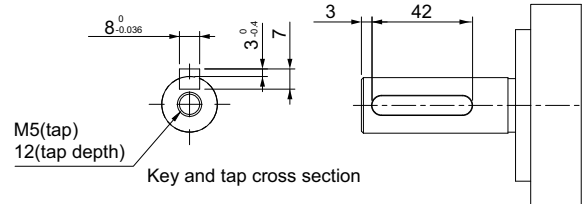

Note: The standard shaft type is a straight shaft. Models with a key and tap are indicated with "S2" at the end of the model number. Models with an oil seal are indicated with "O" at the end of the model number.

3 kW (with Brake)

R88M-1L3K030T-B(O/S2/OS2)

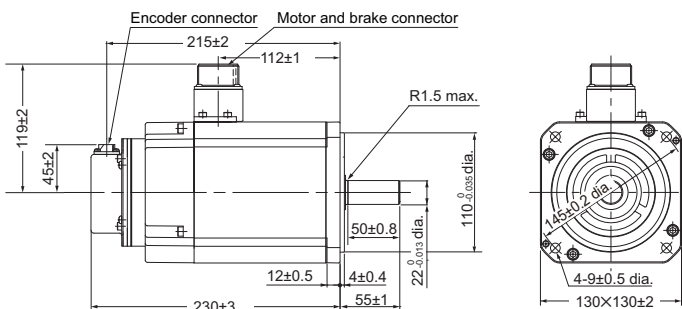

Shaft-end with key and tap

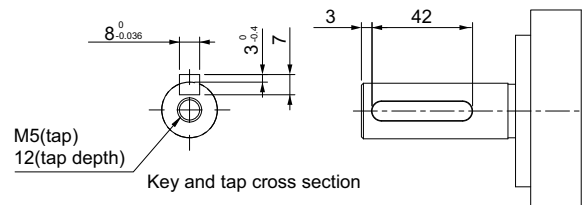

Note: The standard shaft type is a straight shaft. Models with a key and tap are indicated with "S2" at the end of the model number. Models with an oil seal are indicated with "O" at the end of the model number.

AC Servo System 1S-series

3,000-r/min Servomotors (400 V)

750 W/1 kW/1.5 kW/2 kW (without Brake)

R88M-1L75030C(-O/-S2/-OS2)/R88M-1L1K030C(-O/-S2/-OS2)

R88M-1L1K530C(-O/-S2/-OS2)/R88M-1L2K030C(-O/-S2/-OS2)

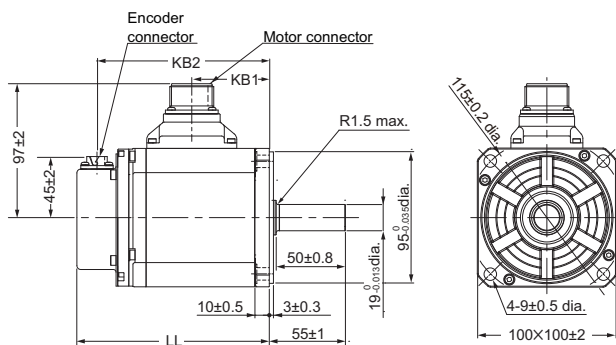

Model	Dimensions [mm]		
	LL	KB1	KB
R88M-1L75030C(-O/-S2/-OS2)	139±2	56±1	124±2
R88M-1L1K030C(-O/-S2/-OS2)	168±2	85±1	153±2
R88M-1L1K530C(-O/-S2/-OS2)	168±2	85±1	153±2
R88M-1L2K030C(-O/-S2/-OS2)	179±2	96±1	164±2

Note: The standard shaft type is a straight shaft. Models with a key and tap are indicated with "S2" at the end of the model number.

Models with an oil seal are indicated with "O" at the end of the model number.

Shaft-end with key and tap

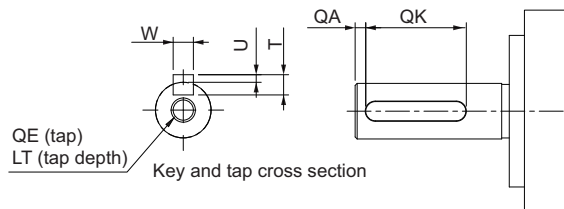

Model	Dimensions [mm]						
	QA	QK	W	T	U	QE	LT
R88M-1L75030C(-S2/-OS2)	3	42	6 ⁰ _{-0.03}	6	2.5 ⁰ _{-0.2}	M5	12
R88M-1L1K030C(-S2/-OS2)	3	42	6 ⁰ _{-0.03}	6	2.5 ⁰ _{-0.2}	M5	12
R88M-1L1K530C(-S2/-OS2)	3	42	6 ⁰ _{-0.03}	6	2.5 ⁰ _{-0.2}	M5	12
R88M-1L2K030C(-S2/-OS2)	3	42	6 ⁰ _{-0.03}	6	2.5 ⁰ _{-0.2}	M5	12

750 W/1 kW/1.5 kW/2 kW (with Brake)

R88M-1L75030C-B(O/S2/OS2)/R88M-1L1K030C-B(O/S2/OS2)

R88M-1L1K530C-B(O/S2/OS2)/R88M-1L2K030C-B(O/S2/OS2)

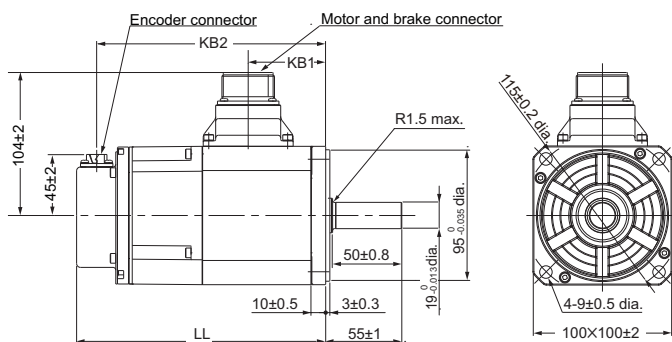

Model	Dimensions [mm]		
	LL	KB1	KB
R88M-1L75030C-B(O/S2/OS2)	180±2	56±1	165±2
R88M-1L1K030C-B(O/S2/OS2)	209±3	85±1	194±2
R88M-1L1K530C-B(O/S2/OS2)	209±3	85±1	194±2
R88M-1L2K030C-B(O/S2/OS2)	220±3	96±1	205±2

Note: The standard shaft type is a straight shaft. Models with a key and tap are indicated with "S2" at the end of the model number.

Models with an oil seal are indicated with "O" at the end of the model number.

Shaft-end with key and tap

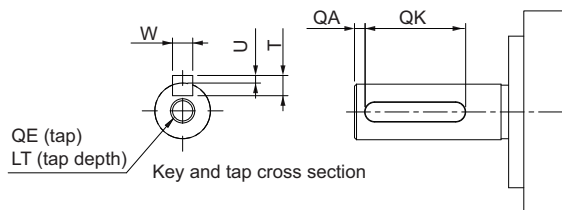

Model	Dimensions [mm]						
	QA	QK	W	T	U	QE	LT
R88M-1L75030C-B(S2/OS2)	3	42	6 ⁰ _{-0.03}	6	2.5 ⁰ _{-0.2}	M5	12
R88M-1L1K030C-B(S2/OS2)	3	42	6 ⁰ _{-0.03}	6	2.5 ⁰ _{-0.2}	M5	12
R88M-1L1K530C-B(S2/OS2)	3	42	6 ⁰ _{-0.03}	6	2.5 ⁰ _{-0.2}	M5	12
R88M-1L2K030C-B(S2/OS2)	3	42	6 ⁰ _{-0.03}	6	2.5 ⁰ _{-0.2}	M5	12

3 kW (without Brake)

R88M-1L3K030C(-O/-S2/-OS2)

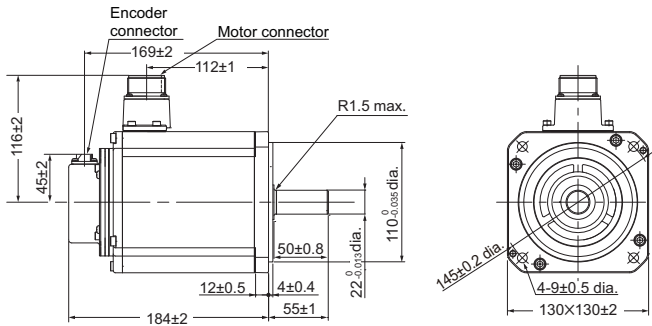

Note: The standard shaft type is a straight shaft. Models with a key and tap are indicated with "S2" at the end of the model number. Models with an oil seal are indicated with "O" at the end of the model number.

Shaft-end with key and tap

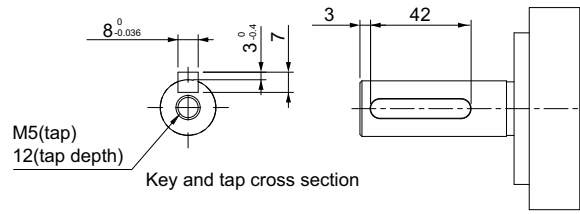

3 kW (with Brake)

R88M-1L3K030C-B(O/S2/OS2)

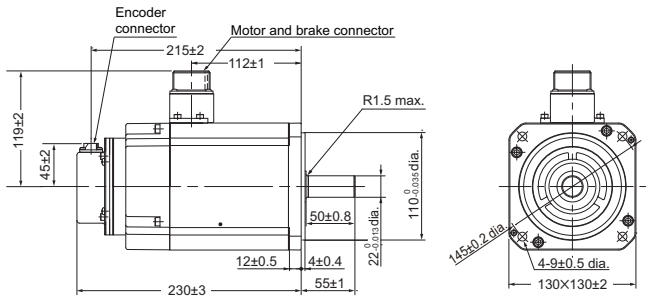

Note: The standard shaft type is a straight shaft. Models with a key and tap are indicated with "S2" at the end of the model number. Models with an oil seal are indicated with "O" at the end of the model number.

Shaft-end with key and tap

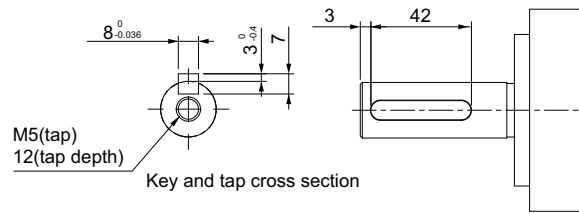

AC Servo System 1S-series

2,000-r/min Servomotors (200 V)

1 kW/1.5 kW/2 kW (without Brake)

R88M-1M1K020T(-O/-S2/-OS2)

R88M-1M1K520T(-O/-S2/-OS2)

R88M-1M2K020T(-O/-S2/-OS2)

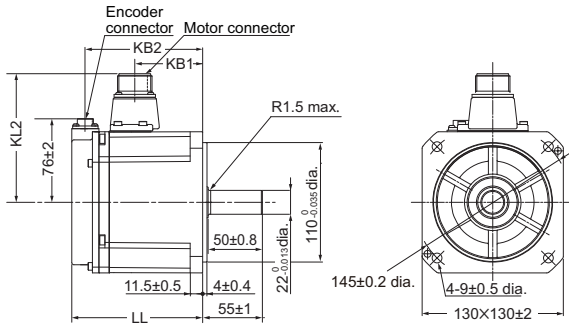

Shaft-end with key and tap

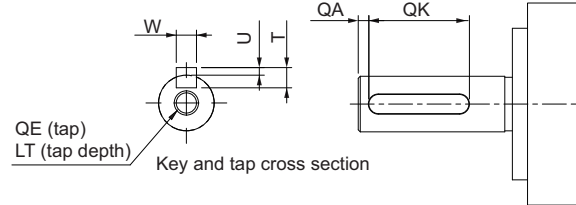

Model	Dimensions [mm]			
	LL	KB1	KB2	KL2
R88M-1M1K020T(-O/-S2/-OS2)	120.5±2	63±1	109±2	118±2
R88M-1M1K520T(-O/-S2/-OS2)	138±2	79±1	125±2	118±2
R88M-1M2K020T(-O/-S2/-OS2)	160±2	99±1	147±2	116±2

Model	Dimensions [mm]						
	QA	QK	W	T	U	QE	LT
R88M-1M1K020T(-S2/-OS2)	3	42	8 ⁰ _{-0.036}	7	3 ⁰ _{-0.4}	M5	12
R88M-1M1K520T(-S2/-OS2)	3	42	8 ⁰ _{-0.036}	7	3 ⁰ _{-0.4}	M5	12
R88M-1M2K020T(-S2/-OS2)	3	42	8 ⁰ _{-0.036}	7	3 ⁰ _{-0.4}	M5	12

Note: The standard shaft type is a straight shaft. Models with a key and tap are indicated with "S2" at the end of the model number. Models with an oil seal are indicated with "O" at the end of the model number.

1 kW/1.5 kW/2 kW (with Brake)

R88M-1M1K020T-B(O/S2/OS2)

R88M-1M1K520T-B(O/S2/OS2)

R88M-1M2K020T-B(O/S2/OS2)

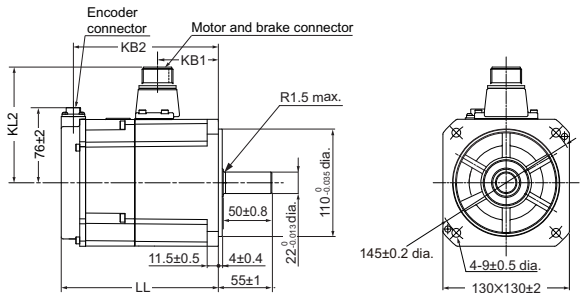

Shaft-end with key and tap

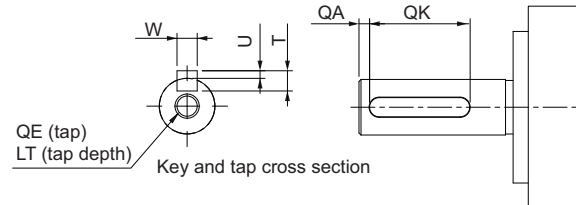

Model	Dimensions [mm]			
	LL	KB1	KB2	KL2
R88M-1M1K020T-B(O/S2/OS2)	162±2	63±1	149±2	118±2
R88M-1M1K520T-B(O/S2/OS2)	179±2	79±1	166±2	118±2
R88M-1M2K020T-B(O/S2/OS2)	201±3	99±1	189±2	119±2

Model	Dimensions [mm]						
	QA	QK	W	T	U	QE	LT
R88M-1M1K020T-B(S2/OS2)	3	42	8 ⁰ _{-0.036}	7	3 ⁰ _{-0.4}	M5	12
R88M-1M1K520T-B(S2/OS2)	3	42	8 ⁰ _{-0.036}	7	3 ⁰ _{-0.4}	M5	12
R88M-1M2K020T-B(S2/OS2)	3	42	8 ⁰ _{-0.036}	7	3 ⁰ _{-0.4}	M5	12

Note: The standard shaft type is a straight shaft. Models with a key and tap are indicated with "S2" at the end of the model number. Models with an oil seal are indicated with "O" at the end of the model number.

3 kW (without Brake)

R88M-1M3K020T(-O/-S2/-OS2)

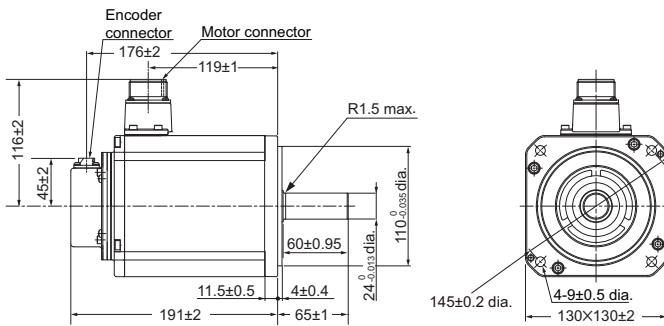

Note: The standard shaft type is a straight shaft. Models with a key and tap are indicated with "S2" at the end of the model number. Models with an oil seal are indicated with "O" at the end of the model number.

Shaft-end with key and tap

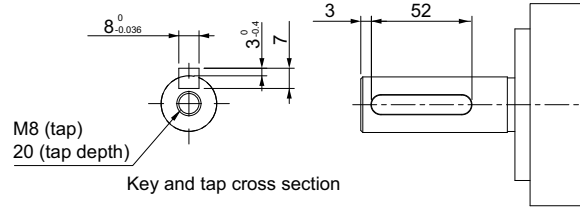

3 kW (with Brake)

R88M-1M3K020T-B(O/S2/OS2)

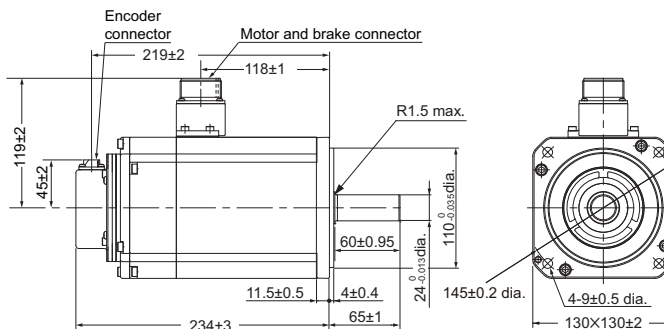

Note: The standard shaft type is a straight shaft. Models with a key and tap are indicated with "S2" at the end of the model number. Models with an oil seal are indicated with "O" at the end of the model number.

Shaft-end with key and tap

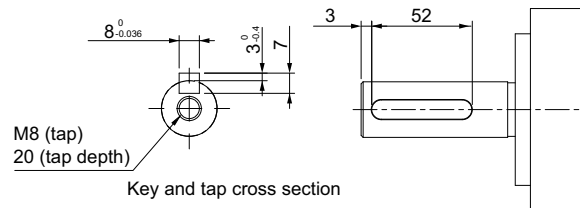

AC Servo System 1S-series

2,000-r/min Servomotors (400 V)

400 W/600 W (without Brake)

R88M-1M40020C(-O/-S2/-OS2)/R88M-1M60020C(-O/-S2/-OS2)

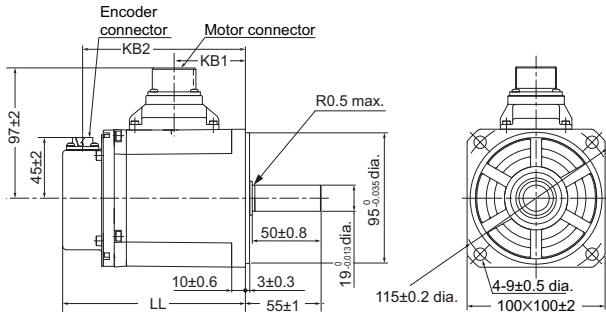

Model	Dimensions [mm]		
	LL	KB1	KB2
R88M-1M40020C(-O/-S2/-OS2)	134.8±1	52±1	120.5±2
R88M-1M60020C(-O/-S2/-OS2)	151.8±1	69±1	137.5±2

Note: The standard shaft type is a straight shaft. Models with a key and tap are indicated with "S2" at the end of the model number. Models with an oil seal are indicated with "O" at the end of the model number.

Shaft-end with key and tap

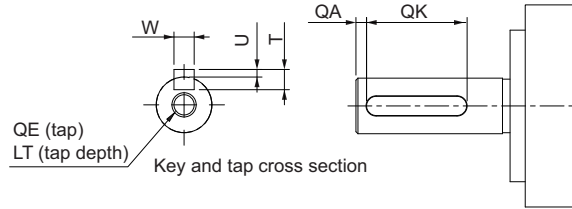

Model	Dimensions [mm]						
	QA	QK	W	T	U	QE	LT
R88M-1M40020C(-S2/-OS2)	3	42	6 ⁰ _{-0.03}	6	2.5 ⁰ _{-0.2}	M5	12
R88M-1M60020C(-S2/-OS2)	3	42	6 ⁰ _{-0.03}	6	2.5 ⁰ _{-0.2}	M5	12

400 W/600 W (with Brake)

R88M-1M40020C-B(O/S2/OS2)/R88M-1M60020C-B(O/S2/OS2)

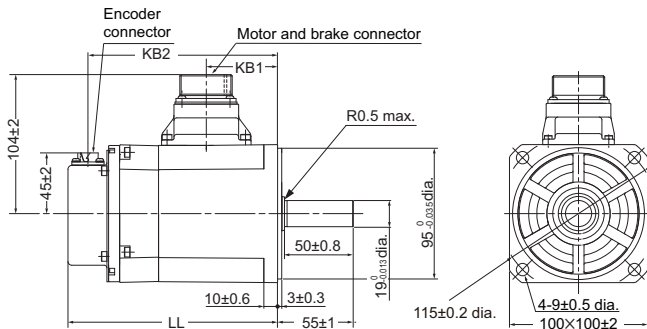

Model	Dimensions [mm]		
	LL	KB1	KB2
R88M-1M40020C-B(O/S2/OS2)	152.3±1	52±1	138±2
R88M-1M60020C-B(O/S2/OS2)	169.3±1	69±1	155±2

Note: The standard shaft type is a straight shaft. Models with a key and tap are indicated with "S2" at the end of the model number. Models with an oil seal are indicated with "O" at the end of the model number.

Shaft-end with key and tap

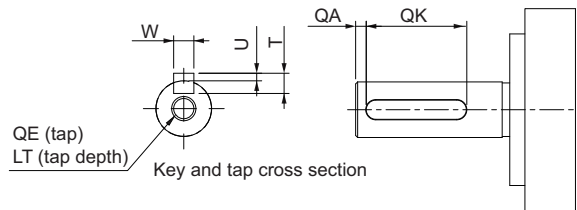

Model	Dimensions [mm]						
	QA	QK	W	T	U	QE	LT
R88M-1M40020C-B(S2/OS2)	3	42	6 ⁰ _{-0.03}	6	2.5 ⁰ _{-0.2}	M5	12
R88M-1M60020C-B(S2/OS2)	3	42	6 ⁰ _{-0.03}	6	2.5 ⁰ _{-0.2}	M5	12

1 kW/1.5 kW/2 kW (without Brake)

R88M-1M1K020C(-O/-S2/-OS2)
 R88M-1M1K520C(-O/-S2/-OS2)
 R88M-1M2K020C(-O/-S2/-OS2)

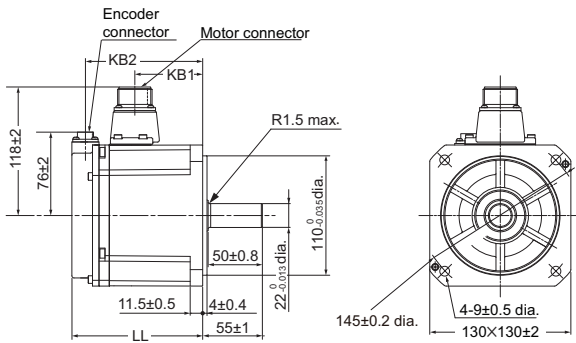

Model	Dimensions [mm]		
	LL	KB1	KB2
R88M-1M1K020C(-O/-S2/-OS2)	120.5±2	63±1	109±2
R88M-1M1K520C(-O/-S2/-OS2)	138±2	79±1	125±2
R88M-1M2K020C(-O/-S2/-OS2)	160±2	98±1	148±2

Note: The standard shaft type is a straight shaft. Models with a key and tap are indicated with "S2" at the end of the model number.
 Models with an oil seal are indicated with "O" at the end of the model number.

Shaft-end with key and tap

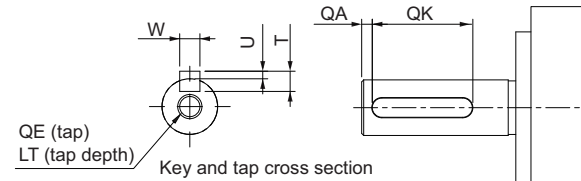

Model	Dimensions [mm]						
	QA	QK	W	T	U	QE	LT
R88M-1M1K020C(-S2/-OS2)	3	42	8 ⁰ _{-0.036}	7	3 ⁰ _{-0.4}	M5	12
R88M-1M1K520C(-S2/-OS2)	3	42	8 ⁰ _{-0.036}	7	3 ⁰ _{-0.4}	M5	12
R88M-1M2K020C(-S2/-OS2)	3	42	8 ⁰ _{-0.036}	7	3 ⁰ _{-0.4}	M5	12

1 kW/1.5 kW/2 kW (with Brake)

R88M-1M1K020C-B(O/S2/OS2)
 R88M-1M1K520C-B(O/S2/OS2)
 R88M-1M2K020C-B(O/S2/OS2)

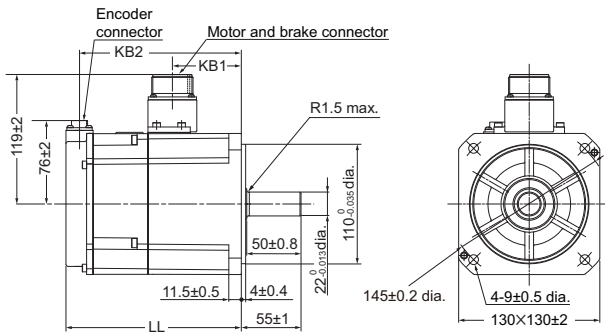

Model	Dimensions [mm]		
	LL	KB1	KB2
R88M-1M1K020C-B(O/S2/OS2)	162±2	64±1	150±2
R88M-1M1K520C-B(O/S2/OS2)	179±2	81±1	167±2
R88M-1M2K020C-B(O/S2/OS2)	201±3	99±1	189±2

Note: The standard shaft type is a straight shaft. Models with a key and tap are indicated with "S2" at the end of the model number.
 Models with an oil seal are indicated with "O" at the end of the model number.

Shaft-end with key and tap

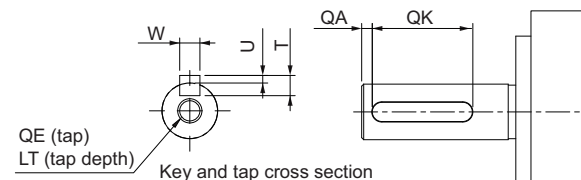

Model	Dimensions [mm]						
	QA	QK	W	T	U	QE	LT
R88M-1M1K020C-B(S2/OS2)	3	42	8 ⁰ _{-0.036}	7	3 ⁰ _{-0.4}	M5	12
R88M-1M1K520C-B(S2/OS2)	3	42	8 ⁰ _{-0.036}	7	3 ⁰ _{-0.4}	M5	12
R88M-1M2K020C-B(S2/OS2)	3	42	8 ⁰ _{-0.036}	7	3 ⁰ _{-0.4}	M5	12

AC Servo System 1S-series

3 kW (without Brake)

R88M-1M3K020C(-O/-S2/-OS2)

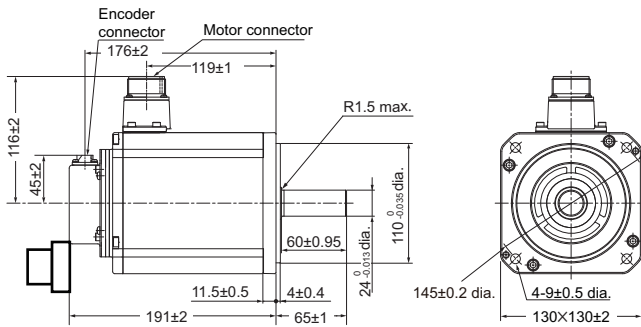

Note: The standard shaft type is a straight shaft. Models with a key and tap are indicated with "S2" at the end of the model number. Models with an oil seal are indicated with "O" at the end of the model number.

Shaft-end with key and tap

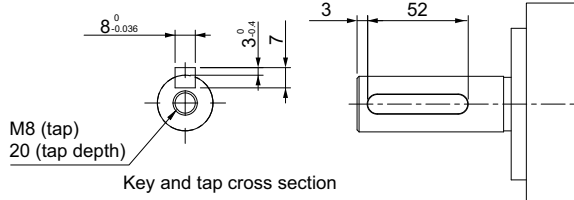

3 kW (with Brake)

R88M-1M3K020C-B(O/S2/OS2)

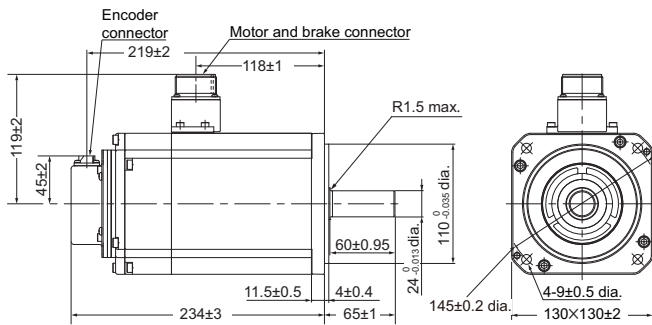

Note: The standard shaft type is a straight shaft. Models with a key and tap are indicated with "S2" at the end of the model number. Models with an oil seal are indicated with "O" at the end of the model number.

Shaft-end with key and tap

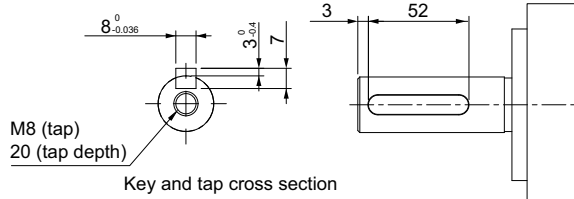

1,000-r/min Servomotors (200 V)

900 W (without Brake)

R88M-1M90010T(-O/S2/OS2)

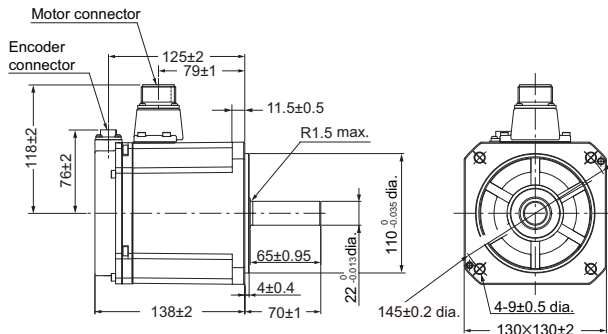

Note: The standard shaft type is a straight shaft. Models with a key and tap are indicated with "S2" at the end of the model number. Models with an oil seal are indicated with "O" at the end of the model number.

Shaft-end with key and tap

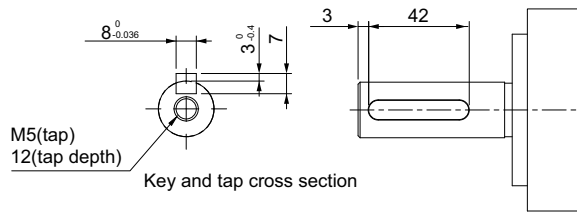

900 W (with Brake)

R88M-1M90010T-B(O/S2/OS2)

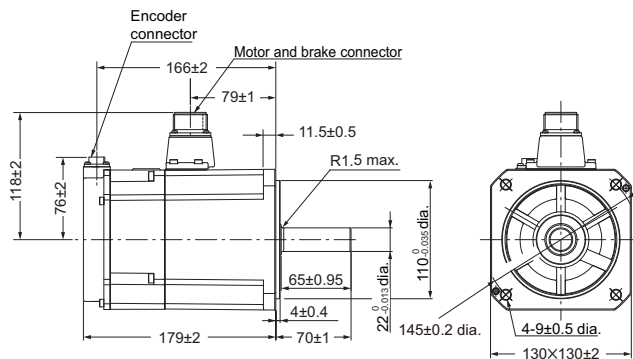

Note: The standard shaft type is a straight shaft. Models with a key and tap are indicated with "S2" at the end of the model number. Models with an oil seal are indicated with "O" at the end of the model number.

Shaft-end with key and tap

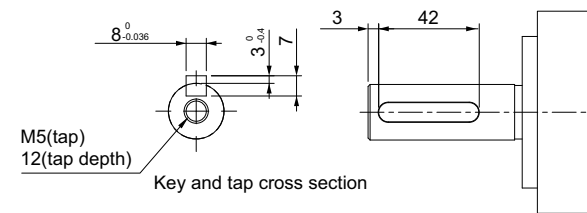

2 kW (without Brake)

R88M-1M2K010T(-O/S2/OS2)

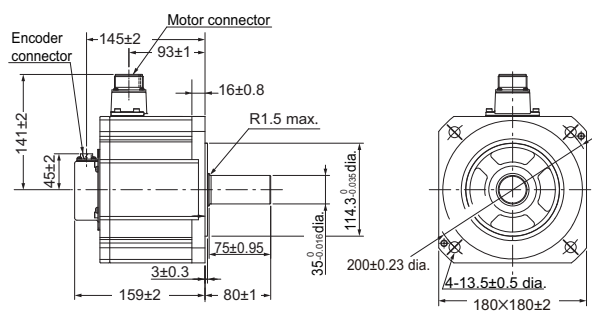

Note: The standard shaft type is a straight shaft. Models with a key and tap are indicated with "S2" at the end of the model number. Models with an oil seal are indicated with "O" at the end of the model number.

Shaft-end with key and tap

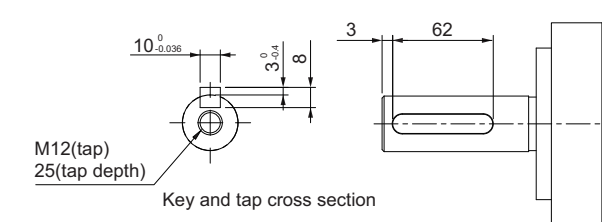

AC Servo System 1S-series

2 kW (with Brake)

R88M-1M2K010T-B(O/S2/OS2)

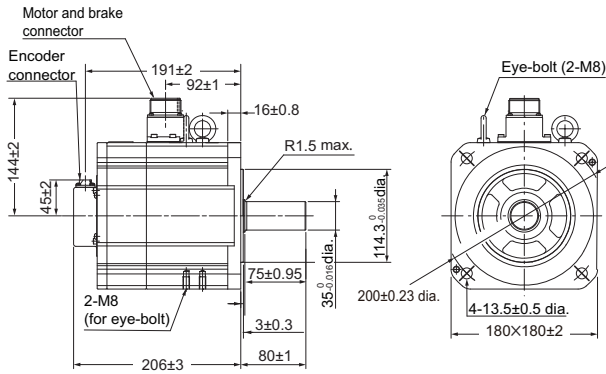

Note: The standard shaft type is a straight shaft. Models with a key and tap are indicated with "S2" at the end of the model number. Models with an oil seal are indicated with "O" at the end of the model number.

Shaft-end with key and tap

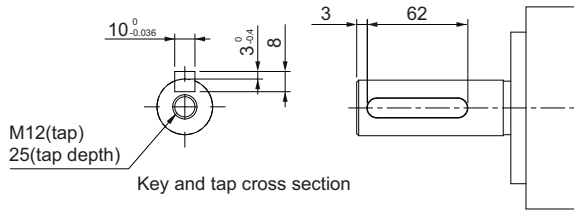

3 kW (without Brake)

R88M-1M3K010T-(O-/S2-/OS2)

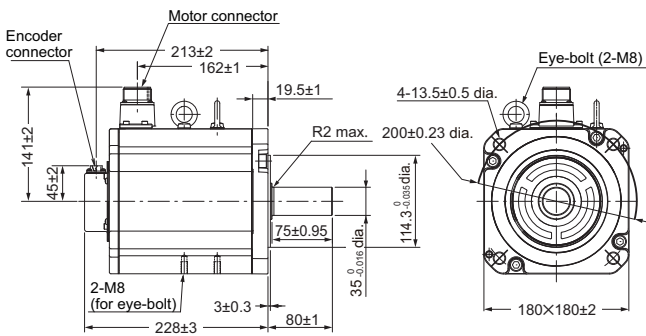

Note: The standard shaft type is a straight shaft. Models with a key and tap are indicated with "S2" at the end of the model number. Models with an oil seal are indicated with "O" at the end of the model number.

Shaft-end with key and tap

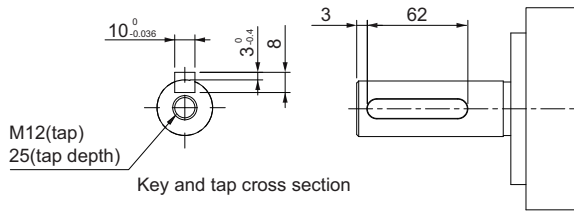

3 kW (with Brake)

R88M-1M3K010T-B(O/S2/OS2)

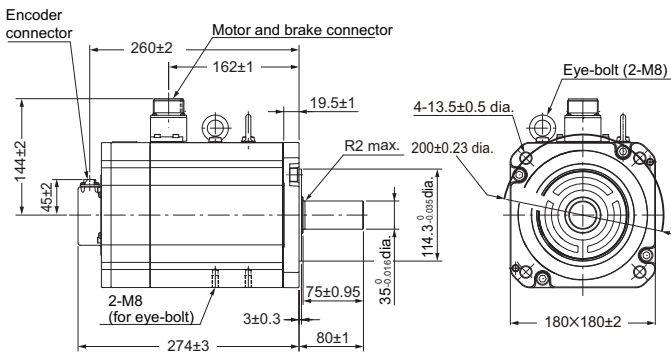

Note: The standard shaft type is a straight shaft. Models with a key and tap are indicated with "S2" at the end of the model number. Models with an oil seal are indicated with "O" at the end of the model number.

Shaft-end with key and tap

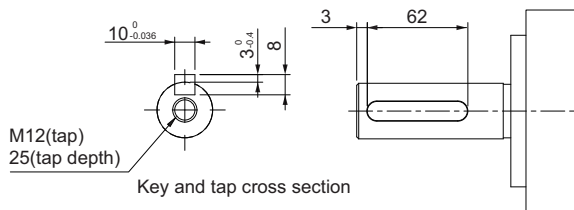

1,000-r/min Servomotors (400 V) 900 W (without Brake) R88M-1M90010C(-O/-S2/-OS2)

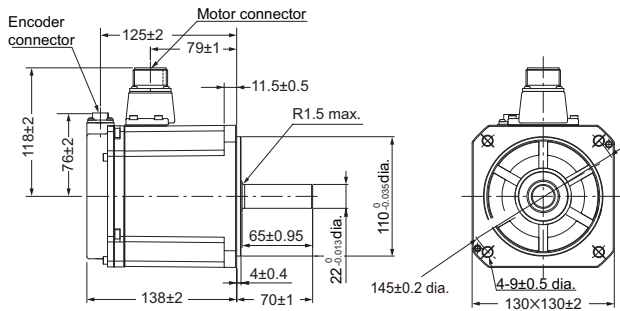

Note: The standard shaft type is a straight shaft. Models with a key and tap are indicated with “S2” at the end of the model number. Models with an oil seal are indicated with “O” at the end of the model number.

Shaft-end with key and tap

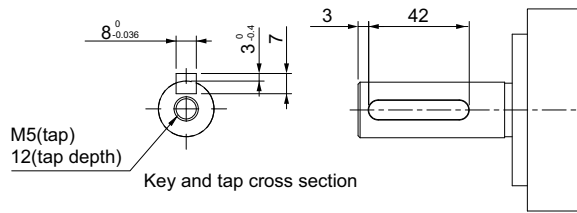

900 W (with Brake) R88M-1M90010C-B(O/S2/OS2)

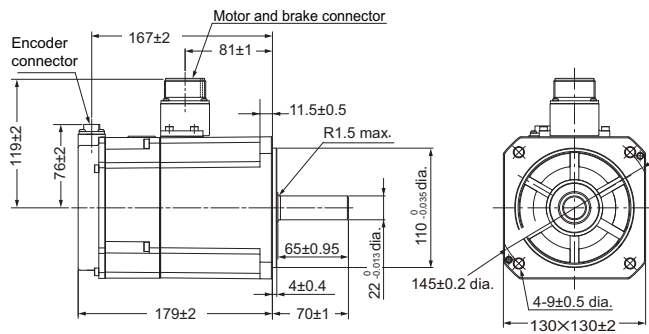

Note: The standard shaft type is a straight shaft. Models with a key and tap are indicated with “S2” at the end of the model number. Models with an oil seal are indicated with “O” at the end of the model number.

Shaft-end with key and tap

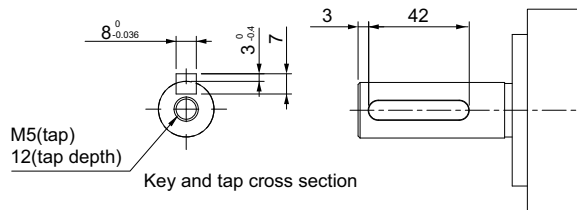

2 kW (without Brake) R88M-1M2K010C(-O/-S2/-OS2)

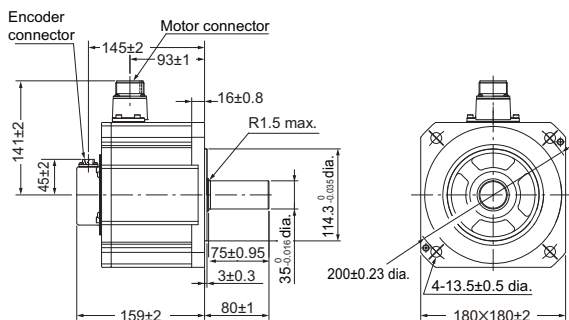

Note: The standard shaft type is a straight shaft. Models with a key and tap are indicated with “S2” at the end of the model number. Models with an oil seal are indicated with “O” at the end of the model number.

Shaft-end with key and tap

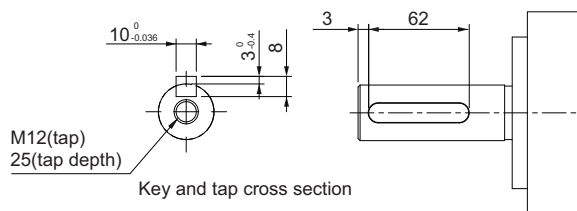

AC Servo System 1S-series

2 kW (with Brake)

R88M-1M2K010C-B(O/S2/OS2)

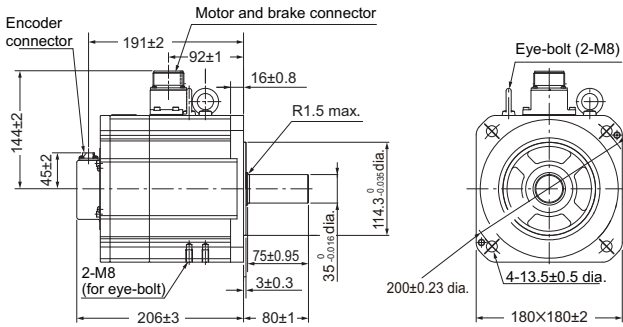

Note: The standard shaft type is a straight shaft. Models with a key and tap are indicated with "S2" at the end of the model number. Models with an oil seal are indicated with "O" at the end of the model number.

Shaft-end with key and tap

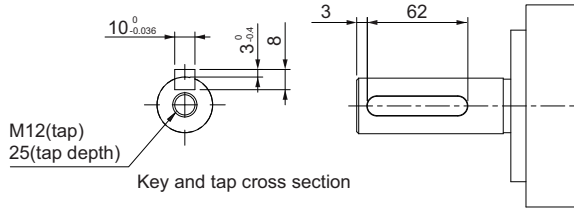

3 kW (without Brake)

R88M-1M3K010C(-O/-S2/-OS2)

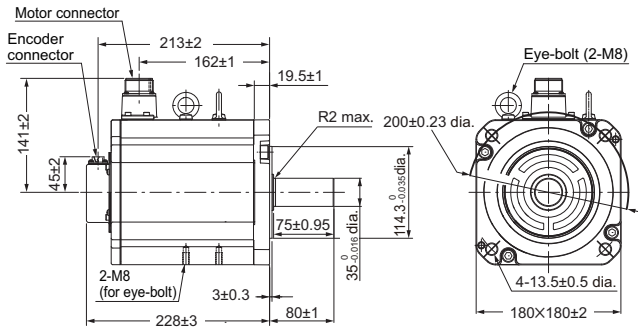

Note: The standard shaft type is a straight shaft. Models with a key and tap are indicated with "S2" at the end of the model number. Models with an oil seal are indicated with "O" at the end of the model number.

Shaft-end with key and tap

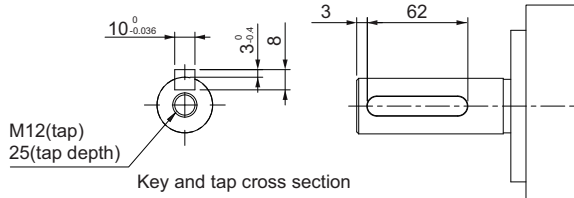

3 kW (with Brake)

R88M-1M3K010C-B(O/S2/OS2)

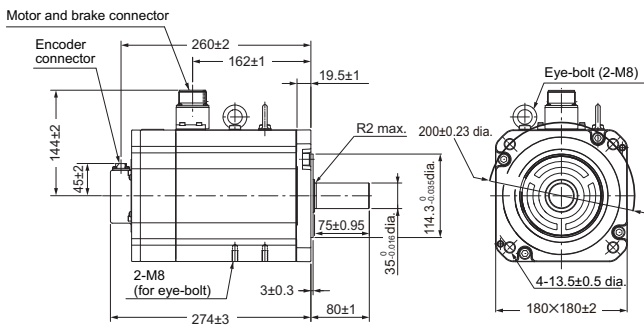

Note: The standard shaft type is a straight shaft. Models with a key and tap are indicated with "S2" at the end of the model number. Models with an oil seal are indicated with "O" at the end of the model number.

Shaft-end with key and tap

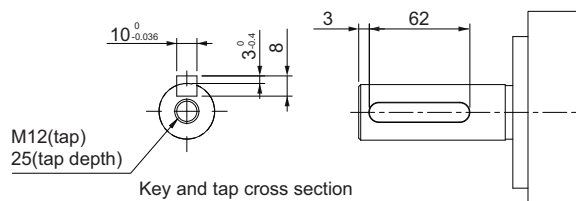

Decelerator AC Servo System [1S-series]

R88G-HPG/VRXF

Contents

- Ordering Information
- Specifications
- External Dimensions

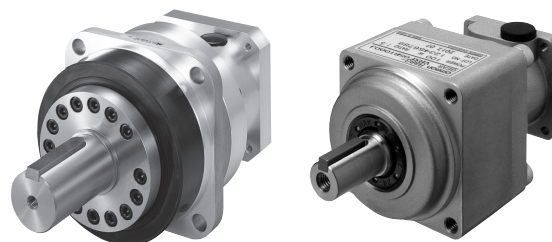

Ordering Information

Refer to the Ordering Information.

Specifications

Backlash: 3 Arcminutes Max.

● For 3,000-r/min Servomotors

Servomotor rated output	Reduction ratio	Model	Rated rotation speed	Rated torque	Efficiency	Momentary maximum rotation speed	Momentary maximum torque	Decelerator inertia	Allowable radial load	Allowable thrust load	Weight
			r/min	N·m	%	r/min	N·m	$\times 10^{-4}$ kg·m ²	N	N	kg
100 W (100 V)	1/5	R88G-HPG11B05100B□	600	1.2	77.0	1200	4.2	0.005	135	538	0.3
	1/11	R88G-HPG14A11100B□	272	2.5	72.1	545	9.0	0.06	280	1119	1.0
	1/21	R88G-HPG14A21100B□	142	5.2	77.8	285	17.5	0.05	340	1358	1.0
	1/33	R88G-HPG20A33100B□	90	6.8	65.2	181	26.9	0.065	916	3226	2.4
	1/45	R88G-HPG20A45100B□	66	9.8	68.2	133	37.1	0.063	1006	3541	2.4
100 W (200 V)	1/5	R88G-HPG11B05100B□	600	1.2	77.0	1200	4.9	0.005	135	538	0.3
	1/11	R88G-HPG14A11100B□	272	2.5	72.1	545	10.6	0.06	280	1119	1.0
	1/21	R88G-HPG14A21100B□	142	5.2	77.8	285	20.7	0.05	340	1358	1.0
	1/33	R88G-HPG20A33100B□	90	6.8	65.2	181	31.9	0.065	916	3226	2.4
	1/45	R88G-HPG20A45100B□	66	9.8	68.2	133	44.0	0.063	1006	3541	2.4
200 W (100 V)	1/5	R88G-HPG14A05200B□	600	2.4	75.4	1200	8.3	0.207	221	883	1.0
	1/11	R88G-HPG14A11200B□	272	5.8	82.6	545	18.8	0.197	280	1119	1.1
	1/21	R88G-HPG20A21200B□	142	10.2	76.2	285	35.9	0.49	800	2817	2.9
	1/33	R88G-HPG20A33200B□	90	17.0	80.6	181	57.3	0.45	916	3226	2.9
	1/45	R88G-HPG20A45200B□	66	23.5	82.1	133	78.5	0.45	1006	3541	2.9
200 W (200 V)	1/5	R88G-HPG14A05200B□	600	2.4	75.4	1200	9.7	0.207	221	883	1.0
	1/11	R88G-HPG14A11200B□	272	5.8	82.6	545	21.8	0.197	280	1119	1.1
	1/21	R88G-HPG20A21200B□	142	10.2	76.2	285	41.7	0.49	800	2817	2.9
	1/33	R88G-HPG20A33200B□	90	17.0	80.6	181	66.5	0.45	916	3226	2.9
	1/45	R88G-HPG20A45200B□	66	23.5	82.1	133	91.1	0.45	1006	3541	2.9
400 W (100 V)	1/5	R88G-HPG14A05400B□	600	5.3	84.2	1200	17.1	0.207	221	883	1.1
	1/11	R88G-HPG20A11400B□	272	11.4	81.6	545	38.1	0.57	659	2320	2.9
	1/21	R88G-HPG20A21400B□	142	23.0	86.1	285	74.0	0.49	800	2817	2.9
	1/33	R88G-HPG32A33400B□	90	33.8	80.7	181	114.0	0.62	1565	6240	7.5
	1/45	R88G-HPG32A45400B□	66	46.6	81.5	133	155.9	0.61	1718	6848	7.5

Servomotor rated output	Reduction ratio	Model	Rated rotation speed	Rated torque	Efficiency	Momentary maximum rotation speed	Momentary maximum torque	Decelerator inertia	Allowable radial load	Allowable thrust load	Weight
			r/min	N·m	%	r/min	N·m	$\times 10^{-4}$ kg·m ²	N	N	kg
400 W (200 V)	1/5	R88G-HPG14A05400B□	600	5.3	84.2	1200	20.4	0.207	221	883	1.1
	1/11	R88G-HPG20A11400B□	272	11.4	81.6	545	45.5	0.57	659	2320	2.9
	1/21	R88G-HPG20A21400B□	142	23.0	86.1	285	88.1	0.49	800	2817	2.9
	1/33	R88G-HPG32A33400B□	90	33.8	80.7	181	136.2	0.62	1565	6240	7.5
	1/45	R88G-HPG32A45400B□	66	46.6	81.5	133	186.1	0.61	1718	6848	7.5
750 W (200 V)	1/5	R88G-HPG20A05750B□	600	9.9	82.9	1200	38.7	0.68	520	1832	2.9
	1/11	R88G-HPG20A11750B□	272	20.0 *1	87.2	545	86.7	0.6	659	2320	3.1
	1/21	R88G-HPG32A21750B□	142	42.1	84.0	285	163.3	3.0	1367	5448	7.8
	1/33	R88G-HPG32A33750B□	90	69.3	87.9	181	259.7	2.7	1565	6240	7.8
	1/45	R88G-HPG32A45750B□	66	94.9	88.3	133	299.0 *2	2.7	1718	6848	7.8
750 W (400 V)	1/5	R88G-HPG32A052K0B□	600	7.7	64.3	1000	30.6	3.8	889	3542	7.4
	1/11	R88G-HPG32A112K0B□	272	20.5	78.0	454	70.9	3.4	1126	4488	7.9
	1/21	R88G-HPG32A211K5B□	142	42.1	84.0	238	138.3	3.0	1367	5448	7.9
	1/33	R88G-HPG32A33600SB□	90	69.3	87.9	151	220.4	2.7	1565	6240	7.9
	1/45	R88G-HPG50A451K5B□	66	92.0	85.5	111	298.0	4.7	4538	15694	19.0
1 kW	1/5	R88G-HPG32A052K0B□	600	11.5	72.2	1000	42.0	3.8	889	3542	7.4
	1/11	R88G-HPG32A112K0B□	272	28.9	82.5	454	96.1	3.4	1126	4488	7.9
	1/21	R88G-HPG32A211K5B□	142	58.1	86.9	238	186.5	3.0	1367	5448	7.9
	1/33	R88G-HPG50A332K0B□	90	90.9	86.7	151	292.7	4.8	4135	14300	19.0
	1/45	R88G-HPG50A451K5B□	66	126.1	88.1	111	401.3	4.7	4538	15694	19.0
1.5 kW	1/5	R88G-HPG32A052K0B□	600	19.1	80.1	1000	64.8	3.8	889	3542	7.4
	1/11	R88G-HPG32A112K0B□	272	45.7	87.0	454	146.3	3.4	1126	4488	7.9
	1/21	R88G-HPG32A211K5B□	142	90.1	90.0	238	282.2	3.0	1367	5448	7.9
	1/33	R88G-HPG50A332K0B□	90	141.3	89.8	151	443.2	4.8	4135	14300	19.0
	1/45	R88G-HPG50A451K5B□	66	194.8	90.8	111	606.5	4.7	4538	15694	19.0
2 kW	1/5	R88G-HPG32A052K0B□	600	26.8	84.1	1000	87.9	3.8	889	3542	7.4
	1/11	R88G-HPG32A112K0B□	272	62.5	89.3	454	197.0	3.4	1126	4488	7.9
	1/21	R88G-HPG50A212K0B□	142	119.0	89.0	238	375.7	5.8	3611	12486	19.0
	1/33	R88G-HPG50A332K0B□	90	192.0	91.3	151	595.3	4.8	4135	14300	19.0
3 kW	1/5	R88G-HPG32A053K0B□	600	42.0	88.1	1000	134.0	3.8	889	3542	7.3
	1/11	R88G-HPG50A113K0B□	272	93.9	89.3	454	296.1	7.7	2974	10285	19.0
	1/21	R88G-HPG50A213K0B□	142	183.1	91.3	238	569.2	5.8	3611	12486	19.0

*1. The value is the allowable continuous output torque of the Decelerator. Take care so that this value is not exceeded.

*2. The value is the maximum allowable torque of the Decelerator. Take care so that this value is not exceeded.

Note: 1. The Decelerator inertia is the Servomotor shaft conversion value.

2. The protective structure rating of the Servomotor with the Decelerator is IP44.

3. The Allowable radial load column shows the values obtained at the center of the shaft (T/2).

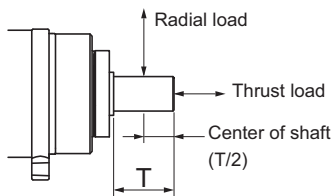

4. The standard shaft type is a straight shaft. A model with a key and tap is indicated with "J" at □ of the model number.

5. Take care so that the surface temperature of the Decelerator does not exceed 70°C.

AC Servo System 1S-series

● For 2,000-r/min Servomotors

Servomotor rated output	Reduction ratio	Model	Rated rotation speed	Rated torque	Efficiency	Momentary maximum rotation speed	Momentary maximum torque	Decelerator inertia	Allowable radial load	Allowable thrust load	Weight
			r/min	N·m	%	r/min	N·m	$\times 10^{-4}$ kg·m ²	N	N	kg
400 W	1/5	R88G-HPG32A052K0B□	400	6.5	68.4	600	24.9	3.8	889	3542	7.4
	1/11	R88G-HPG32A112K0B□	181	16.8	79.9	272	57.1	3.4	1126	4488	7.9
	1/21	R88G-HPG32A211K5B□	95	34.0	84.9	142	111.1	3.0	1367	5448	7.9
	1/33	R88G-HPG32A33600SB□	60	55.6	88.2	90	176.6	2.7	1565	6240	7.9
	1/45	R88G-HPG32A45400SB□	44	76.0	88.5	66	241.1	2.7	1718	6848	7.9
600 W	1/5	R88G-HPG32A052K0B□	400	11.1	77.6	600	38.6	3.8	889	3542	7.4
	1/11	R88G-HPG32A112K0B□	181	26.8	85.3	272	87.3	3.4	1126	4488	7.9
	1/21	R88G-HPG32A211K5B□	95	53.2	88.6	142	168.7	3.0	1367	5448	7.9
	1/33	R88G-HPG32A33600SB□	60	85.7	90.8	90	267.2	2.7	1565	6240	7.9
	1/45	R88G-HPG50A451K5B□	44	115.1	89.4	66	362.6	4.7	4538	15694	19.0
1 kW	1/5	R88G-HPG32A053K0B□	400	20.3	85.0	600	66.0	3.8	889	3542	7.3
	1/11	R88G-HPG32A112K0SB□	181	47.0	89.6	272	147.6	3.4	1126	4488	7.8
	1/21	R88G-HPG32A211K0SB□	95	91.7	91.5	142	283.8	2.9	1367	5448	7.8
	1/33	R88G-HPG50A332K0SB□	60	143.9	91.4	90	445.8	4.7	4135	14300	19.0
	1/45	R88G-HPG50A451K0SB□	44	197.6	92.1	66	609.3	4.7	4538	15694	19.0
1.5 kW	1/5	R88G-HPG32A053K0B□	400	31.7	88.7	600	100.6	3.8	889	3542	7.3
	1/11	R88G-HPG32A112K0SB□	181	72.2	91.7	272	223.7	3.4	1126	4488	7.8
	1/21	R88G-HPG50A213K0B□	95	137.6	91.5	142	426.7	5.8	3611	12486	19.0
	1/33	R88G-HPG50A332K0SB□	60	219.6	92.9	90	673.9	4.7	4135	14300	19.0
2 kW	1/5	R88G-HPG32A053K0B□	400	43.2	90.5	600	135.1	3.8	889	3542	7.3
	1/11	R88G-HPG32A112K0SB□	181	97.5	92.8	272	299.7	3.4	1126	4488	7.8
	1/21	R88G-HPG50A213K0B□	95	185.8	92.7	142	571.9	5.8	3611	12486	19.0
	1/33	R88G-HPG50A332K0SB□	60	270.0 *1	93.5	90	849.0 *2	4.7	4135	14300	19.0
3 kW	1/5	R88G-HPG32A054K0B□	400	66.0	92.3	600	203.8	3.8	889	3542	7.9
	1/11	R88G-HPG50A115K0B□	181	146.1	92.9	272	449.2	8.8	2974	10285	19.1
	1/21	R88G-HPG50A213K0SB□	95	260.0 *1	93.6	142	849.0 *2	6.9	3611	12486	19.1
	1/25	R88G-HPG65A253K0SB□	80	322.9	90.3	120	1011.7	14	7846	28654	52.0

*1. The value is the allowable continuous output torque of the Decelerator. Take care so that this value is not exceeded.

*2. The value is the maximum allowable torque of the Decelerator. Take care so that this value is not exceeded.

Note: 1. The Decelerator inertia is the Servomotor shaft conversion value.

2. The protective structure rating of the Servomotor with the Decelerator is IP44.

3. The Allowable radial load column shows the values obtained at the center of the shaft (T/2).

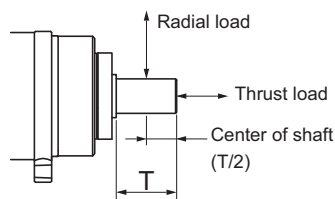

4. The standard shaft type is a straight shaft. A model with a key and tap is indicated with "J" at □ of the model number.

5. Take care so that the surface temperature of the Decelerator does not exceed 70°C.

● For 1,000-r/min Servomotors

Servomotor rated output	Reduction ratio	Model	Rated rotation speed	Rated torque	Efficiency	Momentary maximum rotation speed	Momentary maximum torque	Decelerator inertia	Allowable radial load	Allowable thrust load	Weight
			r/min	N·m	%	r/min	N·m	$\times 10^{-4} \text{ kg}\cdot\text{m}^2$	N	N	kg
900 W	1/5	R88G-HPG32A05900TB□	200	39.8	92.6	400	91.2	3.8	889	3542	7.9
	1/11	R88G-HPG32A11900TB□	90	88.7	93.9	181	201.8	3.4	1126	4488	8.4
	1/21	R88G-HPG50A21900TB□	47	169.2	93.8	95	385.1	7.0	3611	12486	19.1
	1/33	R88G-HPG50A33900TB□	30	267.5	94.4	60	606.8	5.9	4135	14300	19.1
2 kW	1/5	R88G-HPG32A052K0TB□	200	90.2	94.5	400	227.5	5.2	889	3542	8.90
	1/11	R88G-HPG50A112K0TB□	90	198.9	94.7	181	500.9	8.4	2974	10285	20.1
	1/21	R88G-HPG50A212K0TB□	47	320.1 *1	94.8	95	849.0 *2	6.5	3611	12486	20.1
	1/25	R88G-HPG65A255K0SB□	40	446.7	93.6	80	1133.1	14	7846	28654	55.4
3 kW	1/5	R88G-HPG50A055K0SB□	200	135.4	94.4	400	341.8	11	2347	8118	22.0
	1/11	R88G-HPG50A115K0SB□	90	246.2 *1	94.9	181	754.4	8.4	2974	10285	23.5
	1/20	R88G-HPG65A205K0SB□	50	540.4	94.2	100	1366.0	14	7338	26799	55.4
	1/25	R88G-HPG65A255K0SB□	40	677.1	94.4	80	1709.1	14	7846	28654	55.4

*1. The value is the allowable continuous output torque of the Decelerator. Take care so that this value is not exceeded.

*2. The value is the maximum allowable torque of the Decelerator. Take care so that this value is not exceeded.

Note: 1. The Decelerator inertia is the Servomotor shaft conversion value.

2. The protective structure rating of the Servomotor with the Decelerator is IP44.

3. The Allowable radial load column shows the values obtained at the center of the shaft (T/2).

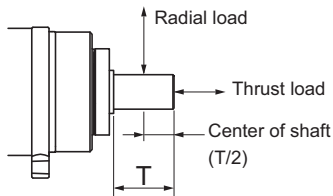

4. The standard shaft type is a straight shaft. A model with a key and tap is indicated with "J" at □ of the model number.

5. Take care so that the surface temperature of the Decelerator does not exceed 70°C.

AC Servo System 1S-series

Backlash: 15 Arcminutes Max.

● For 3,000-r/min Servomotors

Servomotor rated output	Reduction ratio	Model	Rated rotation speed	Rated torque	Efficiency	Momentary maximum rotation speed	Momentary maximum torque	Decelerator inertia	Allowable radial load	Allowable thrust load	Weight
			r/min	N·m	%	r/min	N·m	$\times 10^{-4} \text{ kg}\cdot\text{m}^2$	N	N	kg
100 W (100 V)	1/5	R88G-VRXF05B100CJ	600	1.43	90	1200	4.28	0.060	392	196	0.55
	1/9	R88G-VRXF09B100CJ	333	2.58	90	667	7.70	0.050	441	220	0.55
	1/15	R88G-VRXF15B100CJ	200	4.10	86	400	12.26	0.053	588	294	0.70
	1/25	R88G-VRXF25B100CJ	120	6.84	86	240	20.43	0.051	686	343	0.70
100 W (200 V)	1/5	R88G-VRXF05B100CJ	600	1.43	90	1200	5.00	0.060	392	196	0.55
	1/9	R88G-VRXF09B100CJ	333	2.58	90	667	8.99	0.050	441	220	0.55
	1/15	R88G-VRXF15B100CJ	200	4.10	86	400	14.32	0.053	588	294	0.70
	1/25	R88G-VRXF25B100CJ	120	6.84	86	240	23.87	0.051	686	343	0.70
200 W (100 V)	1/5	R88G-VRXF05B200CJ	600	2.93	92	1200	8.79	0.147	392	196	0.72
	1/9	R88G-VRXF09C200CJ	333	4.76	83	667	14.27	0.237	931	465	1.70
	1/15	R88G-VRXF15C200CJ	200	8.22	86	400	24.64	0.302	1176	588	2.10
	1/25	R88G-VRXF25C200CJ	120	13.70	86	240	41.07	0.293	1323	661	2.10
200 W (200 V)	1/5	R88G-VRXF05B200CJ	600	2.93	92	1200	10.12	0.147	392	196	0.72
	1/9	R88G-VRXF09C200CJ	333	4.76	83	667	16.43	0.237	931	465	1.70
	1/15	R88G-VRXF15C200CJ	200	8.22	86	400	28.38	0.302	1176	588	2.10
	1/25	R88G-VRXF25C200CJ	120	13.70	86	240	47.30	0.293	1323	661	2.10
400 W (100 V)	1/5	R88G-VRXF05C400CJ	600	5.59	88	1200	16.72	0.370	784	392	1.70
	1/9	R88G-VRXF09C400CJ	333	10.06	88	667	30.10	0.237	931	465	1.70
	1/15	R88G-VRXF15C400CJ	200	16.95	89	400	50.73	0.302	1176	588	2.10
	1/25	R88G-VRXF25C400CJ	120	28.26	89	240	84.55	0.293	1323	661	2.10
400 W (200 V)	1/5	R88G-VRXF05C400CJ	600	5.59	88	1200	19.80	0.370	784	392	1.70
	1/9	R88G-VRXF09C400CJ	333	10.06	88	667	35.64	0.237	931	465	1.70
	1/15	R88G-VRXF15C400CJ	200	16.95	89	400	60.08	0.302	1176	588	2.10
	1/25	R88G-VRXF25C400CJ	120	28.26	89	240	100.13	0.293	1323	661	2.10
750 W (200 V)	1/5	R88G-VRXF05C750CJ	600	10.99	92	1200	38.64	0.817	784	392	2.10
	1/9	R88G-VRXF09D750CJ	333	19.57	91	667	68.80	0.755	1176	588	3.40
	1/15	R88G-VRXF15D750CJ	200	31.91	89	400	112.14	0.686	1372	686	3.80
	1/25	R88G-VRXF25D750CJ	120	53.18	89	240	186.90	0.658	1617	808	3.80

- Note:**
1. The Decelerator inertia is the Servomotor shaft conversion value.
 2. The protective structure rating of the Servomotor combined with the Decelerator is IP44. (Excluding decelerator and servo motor connecting parts.)
 3. The Allowable radial load column shows the values obtained at the center of the shaft (T/2).

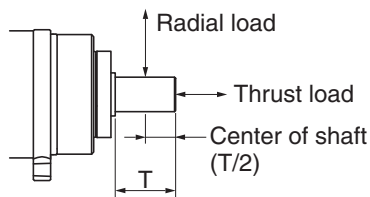

4. The standard shaft type is a shaft with key and tap. (The key is temporarily assembled to the shaft.)
5. Take care so that the surface temperature of the Decelerator does not exceed 90°C.

External Dimensions

(Unit: mm)

Backlash: 3 Arcminutes Max.

● For 3,000-r/min Servomotors (100 to 200 W)

Servomotor rated output	Reduction ratio	Model	Outline drawing	Dimensions [mm]												
				LM	LR	C1	C2	D1	D2	D3	D4	D5	D6*2	E	F1	F2
100 W	1/5	R88G-HPG11B05100B□	1 *1	39.5	42	40	40 × 40	46	46	40	39.5	29	---	27	2.2	15
	1/11	R88G-HPG14A11100B□	1	64.0	58	60	60 × 60	70	46	56	55.5	40	---	37	2.5	21
	1/21	R88G-HPG14A21100B□	1	64.0	58	60	60 × 60	70	46	56	55.5	40	---	37	2.5	21
	1/33	R88G-HPG20A33100B□	2	66.5	80	90	55 dia.	105	46	85	84	59	89	53	7.5	27
	1/45	R88G-HPG20A45100B□	2	66.5	80	90	55 dia.	105	46	85	84	59	89	53	7.5	27
200 W	1/5	R88G-HPG14A05200B□	1	64.0	58	60	60 × 60	70	70	56	55.5	40	---	37	2.5	21
	1/11	R88G-HPG14A11200B□	1	64.0	58	60	60 × 60	70	70	56	55.5	40	---	37	2.5	21
	1/21	R88G-HPG20A21200B□	2	71.0	80	90	89 dia.	105	70	85	84	59	---	53	7.5	27
	1/33	R88G-HPG20A33200B□	2	71.0	80	90	89 dia.	105	70	85	84	59	---	53	7.5	27
	1/45	R88G-HPG20A45200B□	2	71.0	80	90	89 dia.	105	70	85	84	59	---	53	7.5	27

Servomotor rated output	Reduction ratio	Model	Dimensions [mm]											
			G	S	T	Z1	Z2	AT *3	Key				Tap	
									QK	b	h	t1	M	L
100 W	1/5	R88G-HPG11B05100B□	5	8	20	3.4	M4 × 9	M3	15	3	3	1.8	M3	6
	1/11	R88G-HPG14A11100B□	8	16	28	5.5	M4 × 10	M3	25	5	5	3	M4	8
	1/21	R88G-HPG14A21100B□	8	16	28	5.5	M4 × 10	M3	25	5	5	3	M4	8
	1/33	R88G-HPG20A33100B□	10	25	42	9	M4 × 10	M4	36	8	7	4	M6	12
	1/45	R88G-HPG20A45100B□	10	25	42	9	M4 × 10	M4	36	8	7	4	M6	12
200 W	1/5	R88G-HPG14A05200B□	8	16	28	5.5	M4 × 10	M4	25	5	5	3	M4	8
	1/11	R88G-HPG14A11200B□	8	16	28	5.5	M4 × 10	M4	25	5	5	3	M4	8
	1/21	R88G-HPG20A21200B□	10	25	42	9	M4 × 10	M4	36	8	7	4	M6	12
	1/33	R88G-HPG20A33200B□	10	25	42	9	M4 × 10	M4	36	8	7	4	M6	12
	1/45	R88G-HPG20A45200B□	10	25	42	9	M4 × 10	M4	36	8	7	4	M6	12

*1. Two set bolts are positioned at 90° from each other.

*2. D6 is the maximum diameter of the decelerator body between the flange side and Servomotor side. (See Outline Drawing) The value is given only when the diameter is larger than the diameters of these two sides. Take heed of this when you mount the decelerator to the machine.

*3. Indicates set bolt.

Note: 1. The standard shaft type is a straight shaft.

2. A model with a key and tap is indicated with "J" at □ of the model number.
(Example: R88G-HPG11B05100BJ)

3. The diameter of the motor shaft insertion hole is the same as the shaft diameter of the corresponding Servomotor.

4. You cannot use this type of Decelerator for the Servomotor with key.

5. The dimensional drawings in this document are for showing main dimensions only, and they do not give the details of the product shape.

Outline Drawing 1

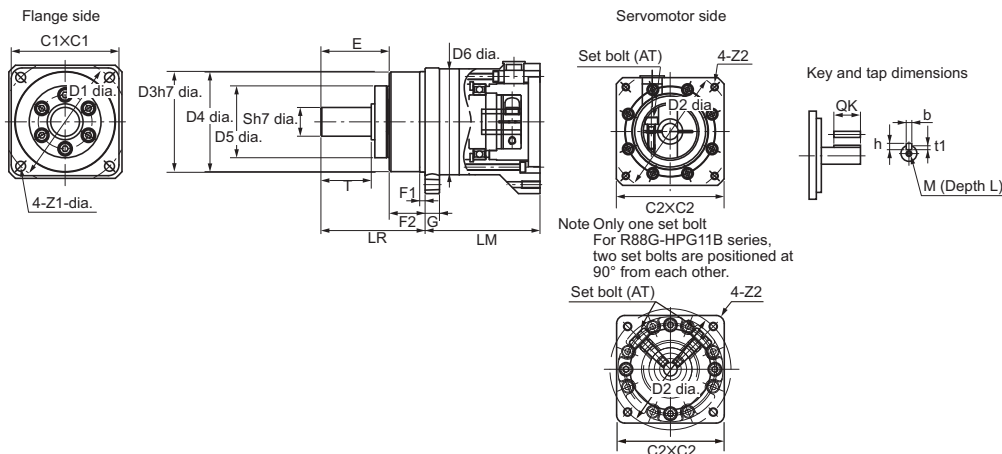

Outline Drawing 2

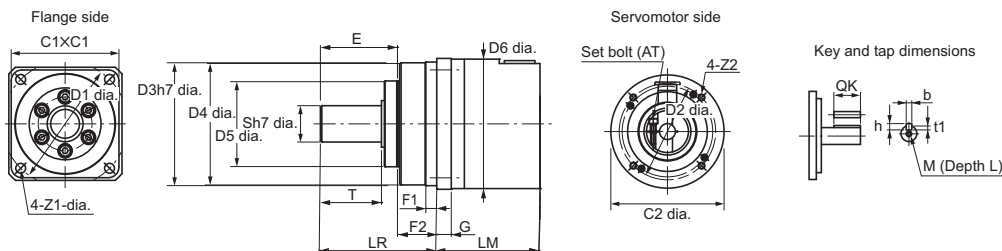

AC Servo System 1S-series

● For 3,000-r/min Servomotors (400 to 750 W)

Servomotor rated output	Reduction ratio	Model	Outline drawing	Dimensions [mm]												
				LM	LR	C1	C2	D1	D2	D3	D4	D5	D6*1	E	F1	F2
400 W	1/5	R88G-HPG14A05400B□	1	64	58	60	60 × 60	70	70	56	55.5	40	---	37	2.5	21
	1/11	R88G-HPG20A11400B□	2	71	80	90	89 dia.	105	70	85	84	59	---	53	7.5	27
	1/21	R88G-HPG20A21400B□	2	71	80	90	89 dia.	105	70	85	84	59	---	53	7.5	27
	1/33	R88G-HPG32A33400B□	2	104	133	120	122 dia.	135	70	115	114	84	---	98	12.5	35
	1/45	R88G-HPG32A45400B□	2	104	133	120	122 dia.	135	70	115	114	84	---	98	12.5	35
750 W (200 V)	1/5	R88G-HPG20A05750B□	1	78	80	90	80 × 80	105	90	85	84	59	89	53	7.5	27
	1/11	R88G-HPG20A11750B□	1	78	80	90	80 × 80	105	90	85	84	59	89	53	7.5	27
	1/21	R88G-HPG32A21750B□	2	104	133	120	122 dia.	135	90	115	114	84	---	98	12.5	35
	1/33	R88G-HPG32A33750B□	2	104	133	120	122 dia.	135	90	115	114	84	---	98	12.5	35
	1/45	R88G-HPG32A45750B□	2	104	133	120	122 dia.	135	90	115	114	84	---	98	12.5	35
750 W (400 V)	1/5	R88G-HPG32A052K0B□	2	110	133	120	135 dia.	135	115	115	114	84	---	98	12.5	35
	1/11	R88G-HPG32A112K0B□	2	110	133	120	135 dia.	135	115	115	114	84	---	98	12.5	35
	1/21	R88G-HPG32A211K5B□	2	110	133	120	135 dia.	135	115	115	114	84	---	98	12.5	35
	1/33	R88G-HPG32A33600SB□	2	110	133	120	135 dia.	135	115	115	114	84	---	98	12.5	35
	1/45	R88G-HPG50A451K5B□	2	123	156	170	170 dia.	190	115	165	163	122	---	103	12	53

Servomotor rated output	Reduction ratio	Model	Dimensions [mm]											
			G	S	T	Z1	Z2	AT *2	Key				Tap	
									QK	b	h	t1	M	L
400 W	1/5	R88G-HPG14A05400B□	8	16	28	5.5	M4 × 10	M4	25	5	5	3	M4	8
	1/11	R88G-HPG20A11400B□	10	25	42	9	M4 × 10	M4	36	8	7	4	M6	12
	1/21	R88G-HPG20A21400B□	10	25	42	9	M4 × 10	M4	36	8	7	4	M6	12
	1/33	R88G-HPG32A33400B□	13	40	82	11	M4 × 10	M4	70	12	8	5	M10	20
	1/45	R88G-HPG32A45400B□	13	40	82	11	M4 × 10	M4	70	12	8	5	M10	20
750 W (200 V)	1/5	R88G-HPG20A05750B□	10	25	42	9	M5 × 12	M4	36	8	7	4	M6	12
	1/11	R88G-HPG20A11750B□	10	25	42	9	M5 × 12	M4	36	8	7	4	M6	12
	1/21	R88G-HPG32A21750B□	13	40	82	11	M5 × 12	M6	70	12	8	5	M10	20
	1/33	R88G-HPG32A33750B□	13	40	82	11	M5 × 12	M6	70	12	8	5	M10	20
	1/45	R88G-HPG32A45750B□	13	40	82	11	M5 × 12	M6	70	12	8	5	M10	20
750 W (400 V)	1/5	R88G-HPG32A052K0B□	13	40	82	11	M8 × 10	M6	70	12	8	5	M10	20
	1/11	R88G-HPG32A112K0B□	13	40	82	11	M8 × 10	M6	70	12	8	5	M10	20
	1/21	R88G-HPG32A211K5B□	13	40	82	11	M8 × 10	M6	70	12	8	5	M10	20
	1/33	R88G-HPG32A33600SB□	13	40	82	11	M8 × 10	M6	70	12	8	5	M10	20
	1/45	R88G-HPG50A451K5B□	16	50	82	14	M8 × 10	M6	70	14	9	5.5	M10	20

*1. D6 is the maximum diameter of the decelerator body between the flange side and Servomotor side. (See Outline Drawing) The value is given only when the diameter is larger than the diameters of these two sides. Take heed of this when you mount the decelerator to the machine.

*2. Indicates set bolt.

Note: 1. The standard shaft type is a straight shaft.

2. A model with a key and tap is indicated with "J" at □ of the model number.
(Example: R88G-HPG14A05400BJ)

3. The diameter of the motor shaft insertion hole is the same as the shaft diameter of the corresponding Servomotor.

4. You cannot use this type of Decelerator for the Servomotor with key.

5. The dimensional drawings in this document are for showing main dimensions only, and they do not give the details of the product shape.

Outline Drawing 1

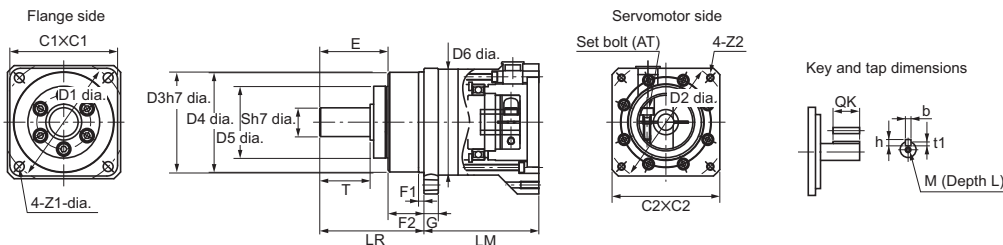

Outline Drawing 2

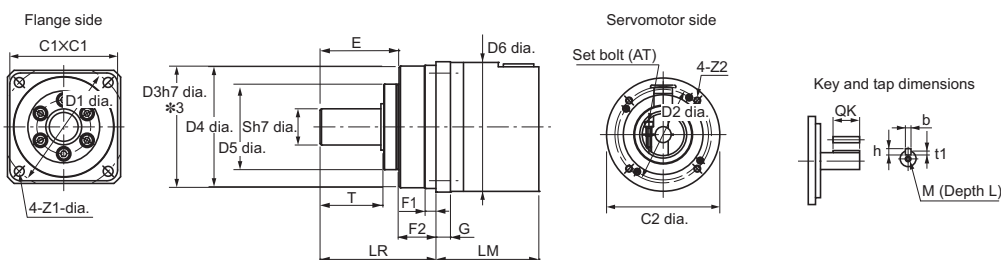

*3. The tolerance is "h8" for R88G-HPG50□.

● For 3,000-r/min Servomotors (1 to 3 kW)

Servomotor rated output	Reduction ratio	Model	Outline drawing	Dimensions [mm]												
				LM	LR	C1	C2	D1	D2	D3	D4	D5	D6*1	E	F1	F2
1 kW	1/5	R88G-HPG32A052K0B□	2	110	133	120	135 dia.	135	115	115	114	84	---	98	12.5	35
	1/11	R88G-HPG32A112K0B□	2	110	133	120	135 dia.	135	115	115	114	84	---	98	12.5	35
	1/21	R88G-HPG32A211K5B□	2	110	133	120	135 dia.	135	115	115	114	84	---	98	12.5	35
	1/33	R88G-HPG50A332K0B□	2	123	156	170	170 dia.	190	115	165	163	122	---	103	12	53
	1/45	R88G-HPG50A451K5B□	2	123	156	170	170 dia.	190	115	165	163	122	---	103	12	53
1.5 kW	1/5	R88G-HPG32A052K0B□	2	110	133	120	135 dia.	135	115	115	114	84	---	98	12.5	35
	1/11	R88G-HPG32A112K0B□	2	110	133	120	135 dia.	135	115	115	114	84	---	98	12.5	35
	1/21	R88G-HPG32A211K5B□	2	110	133	120	135 dia.	135	115	115	114	84	---	98	12.5	35
	1/33	R88G-HPG50A332K0B□	2	123	156	170	170 dia.	190	115	165	163	122	---	103	12	53
	1/45	R88G-HPG50A451K5B□	2	123	156	170	170 dia.	190	115	165	163	122	---	103	12	53
2 kW	1/5	R88G-HPG32A052K0B□	2	110	133	120	135 dia.	135	115	115	114	84	---	98	12.5	35
	1/11	R88G-HPG32A112K0B□	2	110	133	120	135 dia.	135	115	115	114	84	---	98	12.5	35
	1/21	R88G-HPG50A212K0B□	2	123	156	170	170 dia.	190	115	165	163	122	---	103	12	53
	1/33	R88G-HPG50A332K0B□	2	123	156	170	170 dia.	190	115	165	163	122	---	103	12	53
3 kW	1/5	R88G-HPG32A053K0B□	1	107	133	120	130 x 130	135	145	115	114	84	---	98	12.5	35
	1/11	R88G-HPG50A113K0B□	2	123	156	170	170 dia.	190	145	165	163	122	---	103	12	53
	1/21	R88G-HPG50A213K0B□	2	123	156	170	170 dia.	190	145	165	163	122	---	103	12	53

Servomotor rated output	Reduction ratio	Model	Dimensions [mm]													
			G	S	T	Z1	Z2	AT *2	Key				Tap			
				QK	b	h	t1	M	L							
1 kW	1/5	R88G-HPG32A052K0B□	13	40	82	11	M8 x 10	M6	70	12	8	5	M10	20		
	1/11	R88G-HPG32A112K0B□	13	40	82	11	M8 x 10	M6	70	12	8	5	M10	20		
	1/21	R88G-HPG32A211K5B□	13	40	82	11	M8 x 10	M6	70	12	8	5	M10	20		
	1/33	R88G-HPG50A332K0B□	16	50	82	14	M8 x 10	M6	70	14	9	5.5	M10	20		
	1/45	R88G-HPG50A451K5B□	16	50	82	14	M8 x 10	M6	70	14	9	5.5	M10	20		
1.5 kW	1/5	R88G-HPG32A052K0B□	13	40	82	11	M8 x 10	M6	70	12	8	5	M10	20		
	1/11	R88G-HPG32A112K0B□	13	40	82	11	M8 x 10	M6	70	12	8	5	M10	20		
	1/21	R88G-HPG32A211K5B□	13	40	82	11	M8 x 10	M6	70	12	8	5	M10	20		
	1/33	R88G-HPG50A332K0B□	16	50	82	14	M8 x 10	M6	70	14	9	5.5	M10	20		
	1/45	R88G-HPG50A451K5B□	16	50	82	14	M8 x 10	M6	70	14	9	5.5	M10	20		
2 kW	1/5	R88G-HPG32A052K0B□	13	40	82	11	M8 x 10	M6	70	12	8	5	M10	20		
	1/11	R88G-HPG32A112K0B□	13	40	82	11	M8 x 10	M6	70	12	8	5	M10	20		
	1/21	R88G-HPG50A212K0B□	16	50	82	14	M8 x 10	M6	70	14	9	5.5	M10	20		
	1/33	R88G-HPG50A332K0B□	16	50	82	14	M8 x 10	M6	70	14	9	5.5	M10	20		
3 kW	1/5	R88G-HPG32A053K0B□	13	40	82	11	M8 x 18	M6	70	12	8	5	M10	20		
	1/11	R88G-HPG50A113K0B□	16	50	82	14	M8 x 16	M6	70	14	9	5.5	M10	20		
	1/21	R88G-HPG50A213K0B□	16	50	82	14	M8 x 16	M6	70	14	9	5.5	M10	20		

*1. D6 is the maximum diameter of the decelerator body between the flange side and Servomotor side. (See Outline Drawing) The value is given only when the diameter is larger than the diameters of these two sides. Take heed of this when you mount the decelerator to the machine.

*2. Indicates set bolt.

Note: 1. The standard shaft type is a straight shaft.

2. A model with a key and tap is indicated with "J" at □ of the model number.

(Example: R88G-HPG32A052K0BJ)

3. The diameter of the motor shaft insertion hole is the same as the shaft diameter of the corresponding Servomotor.

4. You cannot use this type of Decelerator for the Servomotor with key.

5. The dimensional drawings in this document are for showing main dimensions, and they do not give the details of the product shape.

Outline Drawing 1

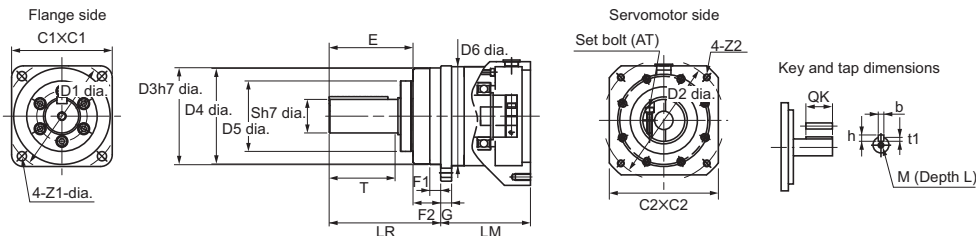

Outline Drawing 2

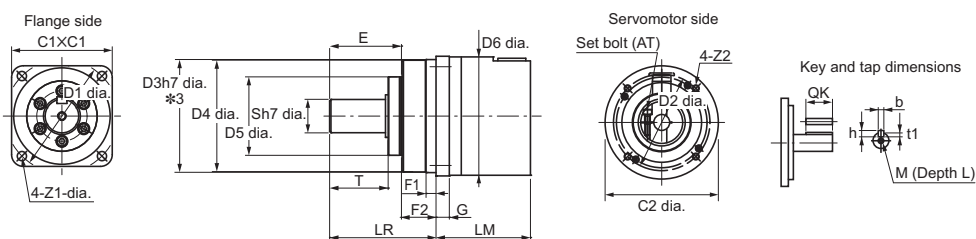

*3. The tolerance is "h8" for R88G-HPG50□.

AC Servo System 1S-series

● For 2,000-r/min Servomotors (400 W to 1 kW)

Servomotor rated output	Reduction ratio	Model	Outline drawing	Dimensions [mm]												
				LM	LR	C1	C2	D1	D2	D3	D4	D5	D6 #1	E	F1	F2
400 W (400 V)	1/5	R88G-HPG32A052K0B□	2	110	133	120	135 dia.	135	115	115	114	84	---	98	12.5	35
	1/11	R88G-HPG32A112K0B□	2	110	133	120	135 dia.	135	115	115	114	84	---	98	12.5	35
	1/21	R88G-HPG32A211K5B□	2	110	133	120	135 dia.	135	115	115	114	84	---	98	12.5	35
	1/33	R88G-HPG32A33600SB□	2	110	133	120	135 dia.	135	115	115	114	84	---	98	12.5	35
	1/45	R88G-HPG32A45400SB□	2	110	133	120	135 dia.	135	115	115	114	84	---	98	12.5	35
600 W (400 V)	1/5	R88G-HPG32A052K0B□	2	110	133	120	135 dia.	135	115	115	114	84	---	98	12.5	35
	1/11	R88G-HPG32A112K0B□	2	110	133	120	135 dia.	135	115	115	114	84	---	98	12.5	35
	1/21	R88G-HPG32A211K5B□	2	110	133	120	135 dia.	135	115	115	114	84	---	98	12.5	35
	1/33	R88G-HPG32A33600SB□	2	110	133	120	135 dia.	135	115	115	114	84	---	98	12.5	35
	1/45	R88G-HPG50A451K5B□	2	123	156	170	170 dia.	190	115	165	163	122	---	103	12	53
1 kW	1/5	R88G-HPG32A053K0B□	1	107	133	120	130 x 130	135	145	115	114	84	---	98	12.5	35
	1/11	R88G-HPG32A112K0SB□	1	107	133	120	130 x 130	135	145	115	114	84	---	98	12.5	35
	1/21	R88G-HPG32A211K0SB□	1	107	133	120	130 x 130	135	145	115	114	84	---	98	12.5	35
	1/33	R88G-HPG50A332K0SB□	2	123	156	170	170 dia.	190	145	165	163	122	---	103	12	53
	1/45	R88G-HPG50A451K0SB□	2	123	156	170	170 dia.	190	145	165	163	122	---	103	12	53

Servomotor rated output	Reduction ratio	Model	Dimensions [mm]											
			G	S	T	Z1	Z2	AT #2	Key				Tap	
									QK	b	h	t1	M	L
400 W (400 V)	1/5	R88G-HPG32A052K0B□	13	40	82	11	M8 x 10	M6	70	12	8	5	M10	20
	1/11	R88G-HPG32A112K0B□	13	40	82	11	M8 x 10	M6	70	12	8	5	M10	20
	1/21	R88G-HPG32A211K5B□	13	40	82	11	M8 x 10	M6	70	12	8	5	M10	20
	1/33	R88G-HPG32A33600SB□	13	40	82	11	M8 x 10	M6	70	12	8	5	M10	20
	1/45	R88G-HPG32A45400SB□	13	40	82	11	M8 x 10	M6	70	12	8	5	M10	20
600 W (400 V)	1/5	R88G-HPG32A052K0B□	13	40	82	11	M8 x 10	M6	70	12	8	5	M10	20
	1/11	R88G-HPG32A112K0B□	13	40	82	11	M8 x 10	M6	70	12	8	5	M10	20
	1/21	R88G-HPG32A211K5B□	13	40	82	11	M8 x 10	M6	70	12	8	5	M10	20
	1/33	R88G-HPG32A33600SB□	13	40	82	11	M8 x 10	M6	70	12	8	5	M10	20
	1/45	R88G-HPG50A451K5B□	16	50	82	14	M8 x 10	M6	70	14	9	5.5	M10	20
1 kW	1/5	R88G-HPG32A053K0B□	13	40	82	11	M8 x 18	M6	70	12	8	5	M10	20
	1/11	R88G-HPG32A112K0SB□	13	40	82	11	M8 x 18	M6	70	12	8	5	M10	20
	1/21	R88G-HPG32A211K0SB□	13	40	82	11	M8 x 18	M6	70	12	8	5	M10	20
	1/33	R88G-HPG50A332K0SB□	16	50	82	14	M8 x 16	M6	70	14	9	5.5	M10	20
	1/45	R88G-HPG50A451K0SB□	16	50	82	14	M8 x 16	M6	70	14	9	5.5	M10	20

*1. D6 is the maximum diameter of the decelerator body between the flange side and Servomotor side. (See Outline Drawing) The value is given only when the diameter is larger than the diameters of these two sides. Take heed of this when you mount the decelerator to the machine.

*2. Indicates set bolt.

Note: 1. The standard shaft type is a straight shaft.

2. A model with a key and tap is indicated with "J" at □ of the model number.
(Example: R88G-HPG32A053K0BJ)

3. The diameter of the motor shaft insertion hole is the same as the shaft diameter of the corresponding Servomotor.

4. You cannot use this type of Decelerator for the Servomotor with key.

5. The dimensional drawings in this document are for showing main dimensions only, and they do not give the details of the product shape.

Outline Drawing 1

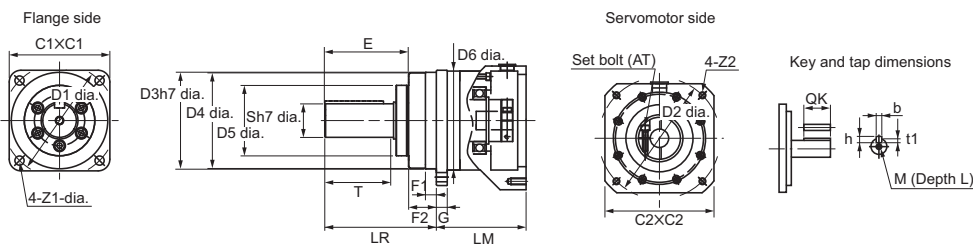

Outline Drawing 2

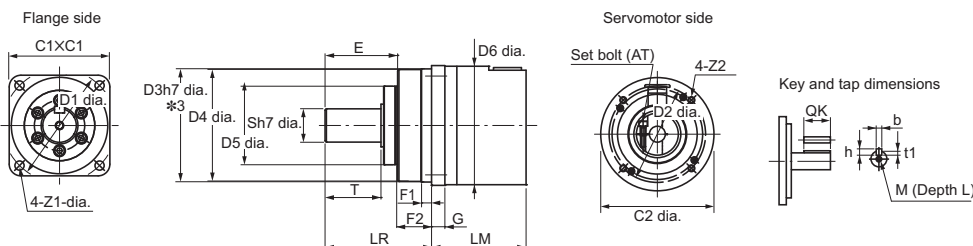

*3. The tolerance is "h8" for R88G-HPG50□.

● For 2,000-r/min Servomotors (1.5 to 3 kW)

Servomotor rated output	Reduction ratio	Model	Outline drawing	Dimensions [mm]												
				LM	LR	C1	C2	D1	D2	D3	D4	D5	D6*1	E	F1	F2
1.5 kW	1/5	R88G-HPG32A053K0B□	1	107	133	120	130 × 130	135	145	115	114	84	---	98	12.5	35
	1/11	R88G-HPG32A112K0SB□	1	107	133	120	130 × 130	135	145	115	114	84	---	98	12.5	35
	1/21	R88G-HPG50A213K0B□	2	123	156	170	170 dia.	190	145	165	163	122	---	103	12	53
	1/33	R88G-HPG50A332K0SB□	2	123	156	170	170 dia.	190	145	165	163	122	---	103	12	53
2 kW	1/5	R88G-HPG32A053K0B□	1	107	133	120	130 × 130	135	145	115	114	84	---	98	12.5	35
	1/11	R88G-HPG32A112K0SB□	1	107	133	120	130 × 130	135	145	115	114	84	---	98	12.5	35
	1/21	R88G-HPG50A213K0B□	2	123	156	170	170 dia.	190	145	165	163	122	---	103	12	53
	1/33	R88G-HPG50A332K0SB□	2	123	156	170	170 dia.	190	145	165	163	122	---	103	12	53
3 kW	1/5	R88G-HPG32A054K0B□	1	129	133	120	130 × 130	135	145	115	114	84	---	98	12.5	35
	1/11	R88G-HPG50A115K0B□	1	149	156	170	130 × 130	190	145	165	163	122	170	103	12	53
	1/21	R88G-HPG50A213K0SB□	1	149	156	170	130 × 130	190	145	165	163	122	170	103	12	53
	1/25	R88G-HPG65A253K0SB□	1	231	222	230	130 × 130	260	145	220	214	168	220	165	12	57

Servomotor rated output	Reduction ratio	Model	Dimensions [mm]												
			G	S	T	Z1	Z2	AT *2	Key				Tap		
									QK	b	h	t1	M	L	
1.5 kW	1/5	R88G-HPG32A053K0B□	13	40	82	11	M8 × 18	M6	70	12	8	5	M10	20	
	1/11	R88G-HPG32A112K0SB□	13	40	82	11	M8 × 18	M6	70	12	8	5	M10	20	
	1/21	R88G-HPG50A213K0B□	16	50	82	14	M8 × 16	M6	70	14	9	5.5	M10	20	
	1/33	R88G-HPG50A332K0SB□	16	50	82	14	M8 × 16	M6	70	14	9	5.5	M10	20	
2 kW	1/5	R88G-HPG32A053K0B□	13	40	82	11	M8 × 18	M6	70	12	8	5	M10	20	
	1/11	R88G-HPG32A112K0SB□	13	40	82	11	M8 × 18	M6	70	12	8	5	M10	20	
	1/21	R88G-HPG50A213K0B□	16	50	82	14	M8 × 16	M6	70	14	9	5.5	M10	20	
	1/33	R88G-HPG50A332K0SB□	16	50	82	14	M8 × 16	M6	70	14	9	5.5	M10	20	
3 kW	1/5	R88G-HPG32A054K0B□	13	40	82	11	M8 × 25	M6	70	12	8	5	M10	20	
	1/11	R88G-HPG50A115K0B□	16	50	82	14	M8 × 25	M6	70	14	9	5.5	M10	20	
	1/21	R88G-HPG50A213K0SB□	16	50	82	14	M8 × 25	M6	70	14	9	5.5	M10	20	
	1/25	R88G-HPG65A253K0SB□	25	80	130	18	M8 × 25	M8	110	22	14	9	M16	35	

*1. D6 is the maximum diameter of the decelerator body between the flange side and Servomotor side. (See Outline Drawing) The value is given only when the diameter is larger than the diameters of these two sides. Take heed of this when you mount the decelerator to the machine.

*2. Indicates set bolt.

Note: 1. The standard shaft type is a straight shaft.

2. A model with a key and tap is indicated with "J" at □ of the model number.
(Example: R88G-HPG32A05900TBJ)

3. The diameter of the motor shaft insertion hole is the same as the shaft diameter of the corresponding Servomotor.

4. You cannot use this type of Decelerator for the Servomotor with key.

5. The dimensional drawings in this document are for showing main dimensions only, and they do not give the details of the product shape.

Outline Drawing 1

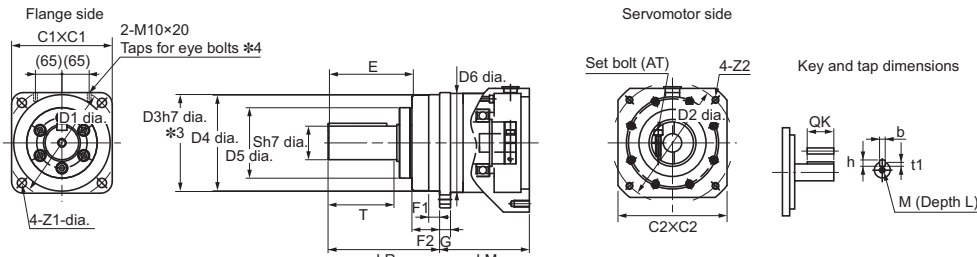

*3. The tolerance is "h8" for R88G-HPG50□ and R88G-HPG65□.

*4. The model R88G-HPG65□ has the taps for eye bolts.

Outline Drawing 2

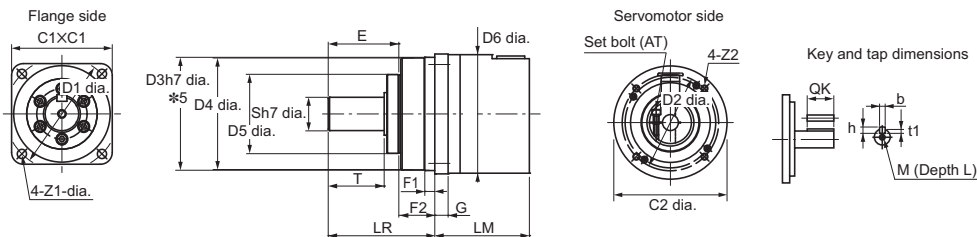

*5. The tolerance is "h8" for R88G-HPG50□.

AC Servo System 1S-series

● For 1,000-r/min Servomotors (900 W to 3 kW)

Servomotor rated output	Reduction ratio	Model	Outline drawing	Dimensions [mm]												
				LM	LR	C1	C2	D1	D2	D3	D4	D5	D6*1	E	F1	F2
900 W	1/5	R88G-HPG32A05900TB□	1	129	133	120	130 × 130	135	145	115	114	84	---	98	12.5	35
	1/11	R88G-HPG32A11900TB□	1	129	133	120	130 × 130	135	145	115	114	84	---	98	12.5	35
	1/21	R88G-HPG50A21900TB□	1	149	156	170	130 × 130	190	145	165	163	122	170	103	12	53
	1/33	R88G-HPG50A33900TB□	1	149	156	170	130 × 130	190	145	165	163	122	170	103	12	53
2 kW	1/5	R88G-HPG32A052K0TB□	1	129	133	120	180 × 180	135	200	115	114	84	---	98	12.5	35
	1/11	R88G-HPG50A112K0TB□	1	149	156	170	180 × 180	190	200	165	163	122	---	103	12	53
	1/21	R88G-HPG50A212K0TB□	1	149	156	170	180 × 180	190	200	165	163	122	---	103	12	53
	1/25	R88G-HPG65A255K0SB□	1	231	222	230	180 × 180	260	200	220	214	168	220	165	12	57
3 kW	1/5	R88G-HPG50A055K0SB□	1	149	156	170	180 × 180	190	200	165	163	122	---	103	12	53
	1/11	R88G-HPG50A115K0SB□	1	149	156	170	180 × 180	190	200	165	163	122	---	103	12	53
	1/20	R88G-HPG65A205K0SB□	1	231	222	230	180 × 180	260	200	220	214	168	220	165	12	57
	1/25	R88G-HPG65A255K0SB□	1	231	222	230	180 × 180	260	200	220	214	168	220	165	12	57

Servomotor rated output	Reduction ratio	Model	Dimensions [mm]											
			G	S	T	Z1	Z2	AT *2	Key				Tap	
									QK	b	h	t1	M	L
900 W	1/5	R88G-HPG32A05900TB□	13	40	82	11	M8 × 25	M6	70	12	8	5	M10	20
	1/11	R88G-HPG32A11900TB□	13	40	82	11	M8 × 25	M6	70	12	8	5	M10	20
	1/21	R88G-HPG50A21900TB□	16	50	82	14	M8 × 25	M6	70	14	9	5.5	M10	20
	1/33	R88G-HPG50A33900TB□	16	50	82	14	M8 × 25	M6	70	14	9	5.5	M10	20
2 kW	1/5	R88G-HPG32A052K0TB□	13	40	82	11	M12 × 25	M6	70	12	8	5	M10	20
	1/11	R88G-HPG50A112K0TB□	16	50	82	14	M12 × 25	M6	70	14	9	5.5	M10	20
	1/21	R88G-HPG50A212K0TB□	16	50	82	14	M12 × 25	M6	70	14	9	5.5	M10	20
	1/25	R88G-HPG65A255K0SB□	25	80	130	18	M12 × 25	M8	110	22	14	9	M16	35
3 kW	1/5	R88G-HPG50A055K0SB□	16	50	82	14	M12 × 25	M6	70	14	9	5.5	M10	20
	1/11	R88G-HPG50A115K0SB□	16	50	82	14	M12 × 25	M6	70	14	9	5.5	M10	20
	1/20	R88G-HPG65A205K0SB□	25	80	130	18	M12 × 25	M8	110	22	14	9	M16	35
	1/25	R88G-HPG65A255K0SB□	25	80	130	18	M12 × 25	M8	110	22	14	9	M16	35

*1. D6 is the maximum diameter of the decelerator body between the flange side and Servomotor side. (See Outline Drawing) The value is given only when the diameter is larger than the diameters of these two sides. Take heed of this when you mount the decelerator to the machine.

*2. Indicates set bolt.

Note: 1. The standard shaft type is a straight shaft.

2. A model with a key and tap is indicated with "J" at □ of the model number.
(Example: R88G-HPG32A05900TBJ)

3. The diameter of the motor shaft insertion hole is the same as the shaft diameter of the corresponding Servomotor.

4. You cannot use this type of Decelerator for the Servomotor with key.

5. The dimensional drawings in this document are for showing main dimensions only, and they do not give the details of the product shape.

Outline Drawing 1

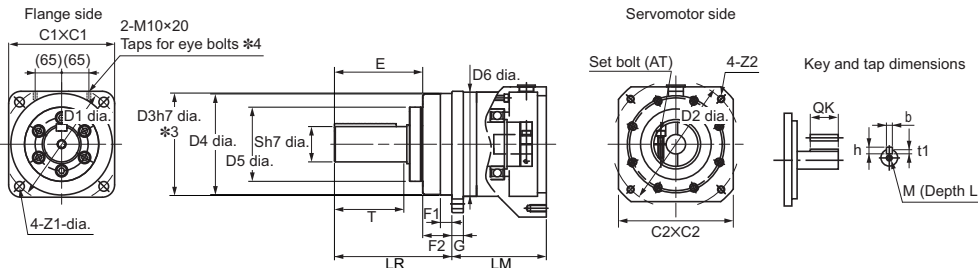

*3. The tolerance is "h8" for R88G-HPG50□ and R88G-HPG65□.

*4. The model R88G-HPG65□ has the taps for eye bolts.

Backlash: 15 Arcminutes Max.

● For 3,000-r/min Servomotors

Model			Dimensions [mm]										
			LM	LR	C1	C2	D1	D2	D3	F	G	S	T
100 W	1/5	R88G-VRXF05B100CJ	67.5	32	40	52	46	60	50	3	6	12	20
	1/9	R88G-VRXF09B100CJ	67.5	32	40	52	46	60	50	3	6	12	20
	1/15	R88G-VRXF15B100CJ	78.0	32	40	52	46	60	50	3	6	12	20
	1/25	R88G-VRXF25B100CJ	78.0	32	40	52	46	60	50	3	6	12	20
200 W	1/5	R88G-VRXF05B200CJ	72.5	32	60	52	70	60	50	3	10	12	20
	1/9	R88G-VRXF09C200CJ	89.5	50	60	78	70	90	70	3	8	19	30
	1/15	R88G-VRXF15C200CJ	100.0	50	60	78	70	90	70	3	8	19	30
	1/25	R88G-VRXF25C200CJ	100.0	50	60	78	70	90	70	3	8	19	30
400 W	1/5	R88G-VRXF05C400CJ	89.5	50	60	78	70	90	70	3	8	19	30
	1/9	R88G-VRXF09C400CJ	89.5	50	60	78	70	90	70	3	8	19	30
	1/15	R88G-VRXF15C400CJ	100.0	50	60	78	70	90	70	3	8	19	30
	1/25	R88G-VRXF25C400CJ	100.0	50	60	78	70	90	70	3	8	19	30
750 W (200 V)	1/5	R88G-VRXF05C750CJ	93.5	50	80	78	90	90	70	3	10	19	30
	1/9	R88G-VRXF09D750CJ	97.5	61	80	98	90	115	90	5	10	24	40
	1/15	R88G-VRXF15D750CJ	110.0	61	80	98	90	115	90	5	10	24	40
	1/25	R88G-VRXF25D750CJ	110.0	61	80	98	90	115	90	5	10	24	40

Model			Dimensions [mm]									
			Z1	Z2	AT *	L	Key				Tap	
							QK	b	h	t1	m	l
100 W	1/5	R88G-VRXF05B100CJ	M4	M5	M4	12	16	4	4	2.5	M5	10
	1/9	R88G-VRXF09B100CJ	M4	M5	M4	12	16	4	4	2.5	M5	10
	1/15	R88G-VRXF15B100CJ	M4	M5	M4	12	16	4	4	2.5	M5	10
	1/25	R88G-VRXF25B100CJ	M4	M5	M4	12	16	4	4	2.5	M5	10
200 W	1/5	R88G-VRXF05B200CJ	M4	M5	M4	12	16	4	4	2.5	M5	10
	1/9	R88G-VRXF09C200CJ	M4	M6	M5	20	22	6	6	3.5	M6	12
	1/15	R88G-VRXF15C200CJ	M4	M6	M5	20	22	6	6	3.5	M6	12
	1/25	R88G-VRXF25C200CJ	M4	M6	M5	20	22	6	6	3.5	M6	12
400 W	1/5	R88G-VRXF05C400CJ	M4	M6	M5	20	22	6	6	3.5	M6	12
	1/9	R88G-VRXF09C400CJ	M4	M6	M5	20	22	6	6	3.5	M6	12
	1/15	R88G-VRXF15C400CJ	M4	M6	M5	20	22	6	6	3.5	M6	12
	1/25	R88G-VRXF25C400CJ	M4	M6	M5	20	22	6	6	3.5	M6	12
750 W (200 V)	1/5	R88G-VRXF05C750CJ	M5	M6	M6	20	22	6	6	3.5	M6	12
	1/9	R88G-VRXF09D750CJ	M5	M8	M6	20	30	8	7	4	M8	16
	1/15	R88G-VRXF15D750CJ	M5	M8	M6	20	30	8	7	4	M8	16
	1/25	R88G-VRXF25D750CJ	M5	M8	M6	20	30	8	7	4	M8	16

* Indicates set bolt.

Note: 1. The standard shaft type is a shaft with key and tap.

2. The diameter of the motor shaft insertion hole is the same as the shaft diameter of the corresponding Servomotor.

3. You cannot use this type of Decelerator for the Servomotor with key.

4. The dimensional drawings in this document are for showing main dimensions only, and they do not give the details of the product shape.

Outline Drawing

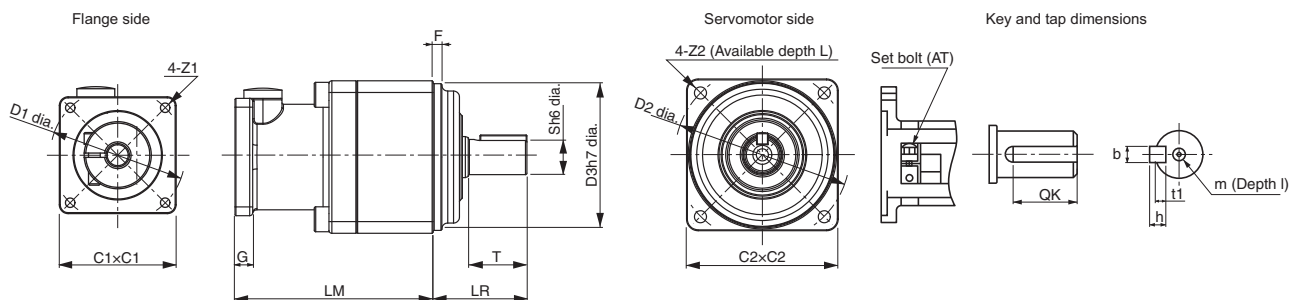

Ordering Information

Interpreting Model Numbers	66
AC Servo Drives with Built-in EtherCAT Communications.....	66
AC Servomotor.....	66
Decelerator Backlash: 3 Arcminutes Max.	67
Table of AC Servomotor Variations.....	68
Ordering Information	69
AC Servo Drives with Built-in EtherCAT Communications.....	69
AC Servomotors.....	69
Decelerator (Backlash: 3 Arcminutes Max./15 Arcminutes Max.)	72
Cables and Peripheral Devices.....	73
Software	79
Combination table	80
Cable Connection Configuration	82
Related Manuals	85
Mechatronics Sizing Tool for AC Servo Motors	86

AC Servo System 1S-series

Interpreting Model Numbers

AC Servo Drives with Built-in EtherCAT Communications

R88D-1S N 01 H -ECT

(1) (2) (3) (4) (5)

No	Item	Symbol	Specifications
(1)	1S-series Servo Drive		
(2)	Servo Drive Type	N	Communication type
(3)	Applicable Servomotor rated output	01	100 W
		02	200 W
		04	400 W
		06	600 W
		08	750 W
		10	1 kW
		15	1.5 kW
		20	2 kW
(4)	Power Supply Voltage	L	100 VAC
		H	200 VAC
		F	400 VAC
(5)	Communications type	ECT	EtherCAT Communications

AC Servomotor

R88M-1 M 100 30 S -BOS2

(1) (2) (3) (4) (5) (6)

No	Item	Symbol	Specifications
(1)	1S-series Servomotor		
(2)	Servomotor Type	L	Low inertia
(3)	Rated output	M	Middle inertia
		100	100 W
		200	200 W
		400	400 W
		600	600 W
		750	750 W
		900	900 W
		1K0	1 kW
		1K5	1.5 kW
		2K0	2 kW
		3K0	3 kW
(4)	Rated rotation speed	10	1,000 r/min
		20	2,000 r/min
		30	3,000 r/min
(5)	Servo Drive main power supply voltage and encoder type	S	100 VAC absolute encoder
		T	200 VAC absolute encoder
		C	400 VAC absolute encoder
(6)	Options		
	Brake	None	Without brake
		B	With 24-VDC brake
	Oil seal	None	Without oil seal
		O	With oil seal
	Key and tap	None	Straight shaft
S2		With key and tap	

Decelerator

Backlash: 3 Arcminutes Max.

R88G-HPG 14A 05 100 S B J

(1) (2) (3) (4) (5) (6) (7)

No	Item	Symbol	Specifications
(1)	Decelerator for Servomotor Backlash: 3 Arcminutes max.		
(2)	Flange size number	11B	40 × 40
		14A	60 × 60
		20A	90 × 90
		32A	120 × 120
		50A	170 × 170
		65A	230 × 230
(3)	Reduction ratio	05	1/5
		11	1/11
		20	1/20
		21	1/21
		25	1/25
		33	1/33
		45	1/45
(4)	Applicable Servomotor rated output *	100	100 W
		200	200 W
		400	400 W
		600	600 W
		750	750 W
		900	900 W
		1K0	1 kW
		1K5	1.5 kW
		2K0	2 kW
		3K0	3 kW
		4K0	4 kW
		5K0	5 kW
(5)	Motor type	None	3,000-r/min Servomotors
		S	2,000-r/min Servomotors
		T	1,000-r/min Servomotors
(6)	Backlash	B	Backlash: 3 Arcminutes max.
(7)	Option	None	Straight shaft
		J	With key and tap

* This is based on the rated output of a typical applicable Servomotor. For the selection, check the Servomotor and Decelerator Combination Tables.

Backlash: 15 Arcminutes Max.

R88G-VRXF 09 B 100 C J

(1) (2) (3) (4) (5) (6)

No	Item	Symbol	Specifications
(1)	Decelerator for Servomotor Backlash: 15 Arcminutes max.		
(2)	Gear Ratio	05	1/5
		09	1/9
		15	1/15
		25	1/25
(3)	Flange Size Number	B	□52
		C	□78
		D	□98
(4)	Applicable Servomotor rated output *	100	100 W
		200	200 W
		400	400 W
		750	750 W
(5)	Backlash	C	Backlash: 15 Arcminutes Max
(6)	Option	J	With key and tap

* This is based on the rated output of a typical applicable Servomotor. For the selection, check the Servomotor and Decelerator Combination Tables.

AC Servo System 1S-series

Table of AC Servomotor Variations

R88M-1 -

(2) (3) (4) (5) (6) (7) (8)

(2) Type	(3) Rated output	(4) Rotation speed	Model	(5) Power supply specifications			(6) Brake		(7) Oil seal		(8) Shaft type	
				ABS 400	ABS 200	ABS 100	None	B	None	O	None	S2
				C	T	S						
				C: 400 VAC (with absolute encoder) ABS/INC T: 200 VAC (with absolute encoder) ABS/INC S: 100 VAC (with absolute encoder) ABS/INC								
M	100 W	3,000 r/min	R88M-1M10030		✓	✓	✓	✓	✓	✓	✓	✓
	200 W		R88M-1M20030		✓	✓	✓	✓	✓	✓	✓	✓
	400 W		R88M-1M40030		✓	✓	✓	✓	✓	✓	✓	✓
	750 W		R88M-1M75030		✓		✓	✓	✓	✓	✓	✓
L	750 W	3,000 r/min	R88M-1L75030	✓			✓	✓	✓	✓	✓	✓
	1 kW		R88M-1L1K030	✓	✓		✓	✓	✓	✓	✓	✓
	1.5 kW		R88M-1L1K530	✓	✓		✓	✓	✓	✓	✓	✓
	2 kW		R88M-1L2K030	✓	✓		✓	✓	✓	✓	✓	✓
M	3 kW	2,000 r/min	R88M-1L3K030	✓	✓		✓	✓	✓	✓	✓	✓
	400 W		R88M-1M40020	✓			✓	✓	✓	✓	✓	✓
	600 W		R88M-1M60020	✓			✓	✓	✓	✓	✓	✓
	1 kW		R88M-1M1K020	✓	✓		✓	✓	✓	✓	✓	✓
M	1.5 kW	2,000 r/min	R88M-1M1K520	✓	✓		✓	✓	✓	✓	✓	✓
	2 kW		R88M-1M2K020	✓	✓		✓	✓	✓	✓	✓	✓
	3 kW		R88M-1M3K020	✓	✓		✓	✓	✓	✓	✓	✓
	900 W		R88M-1M90010	✓	✓		✓	✓	✓	✓	✓	✓
M	2 kW	1,000 r/min	R88M-1M2K010	✓	✓		✓	✓	✓	✓	✓	✓
	3 kW		R88M-1M3K010	✓	✓		✓	✓	✓	✓	✓	✓
M: Middle inertia L: Low inertia	100: 100 W 1K0: 1 kW 3K0: 3 kW	10: 1,000 r/min 20: 2,000 r/min 30: 3,000 r/min		C: 400 VAC (with absolute encoder) ABS/INC T: 200 VAC (with absolute encoder) ABS/INC S: 100 VAC (with absolute encoder) ABS/INC			None: Without brake B: With 24-VDC brake	None: Without oil seal O: With oil seal	None: Straight shaft S2: With key and tap			

Ordering Information

AC Servo Drives with Built-in EtherCAT Communications

Power supply voltage	Rated output	Model
Single-phase 100 VAC	100 W	R88D-1SN01L-ECT
	200 W	R88D-1SN02L-ECT
	400 W	R88D-1SN04L-ECT
Single-phase/3-phase 200 VAC	100 W	R88D-1SN01H-ECT
	200 W	R88D-1SN02H-ECT
	400 W	R88D-1SN04H-ECT
	750 W	R88D-1SN08H-ECT
	1.5 kW	R88D-1SN15H-ECT
3-phase 200 VAC	1 kW	R88D-1SN10H-ECT
	2 kW	R88D-1SN20H-ECT
	3 kW	R88D-1SN30H-ECT
3-phase 400 VAC	600 W	R88D-1SN06F-ECT
	1 kW	R88D-1SN10F-ECT
	1.5 kW	R88D-1SN15F-ECT
	2 kW	R88D-1SN20F-ECT
	3 kW	R88D-1SN30F-ECT

AC Servomotors

● 3,000-r/min Servomotors

Specifications			Model	
			Without oil seal	
			Straight shaft	With key and tap
Without brake	100 VAC	100 W	R88M-1M10030S	R88M-1M10030S-S2
		200 W	R88M-1M20030S	R88M-1M20030S-S2
		400 W	R88M-1M40030S	R88M-1M40030S-S2
	200 VAC	100 W	R88M-1M10030T	R88M-1M10030T-S2
		200 W	R88M-1M20030T	R88M-1M20030T-S2
		400 W	R88M-1M40030T	R88M-1M40030T-S2
		750 W	R88M-1M75030T	R88M-1M75030T-S2
		1 kW	R88M-1L1K030T	R88M-1L1K030T-S2
		1.5 kW	R88M-1L1K530T	R88M-1L1K530T-S2
		2 kW	R88M-1L2K030T	R88M-1L2K030T-S2
	3 kW	R88M-1L3K030T	R88M-1L3K030T-S2	
	400 VAC	750 W	R88M-1L75030C	R88M-1L75030C-S2
		1 kW	R88M-1L1K030C	R88M-1L1K030C-S2
		1.5 kW	R88M-1L1K530C	R88M-1L1K530C-S2
		2 kW	R88M-1L2K030C	R88M-1L2K030C-S2
3 kW		R88M-1L3K030C	R88M-1L3K030C-S2	
With brake	100 VAC	100 W	R88M-1M10030S-B	R88M-1M10030S-BS2
		200 W	R88M-1M20030S-B	R88M-1M20030S-BS2
		400 W	R88M-1M40030S-B	R88M-1M40030S-BS2
	200 VAC	100 W	R88M-1M10030T-B	R88M-1M10030T-BS2
		200 W	R88M-1M20030T-B	R88M-1M20030T-BS2
		400 W	R88M-1M40030T-B	R88M-1M40030T-BS2
		750 W	R88M-1M75030T-B	R88M-1M75030T-BS2
		1 kW	R88M-1L1K030T-B	R88M-1L1K030T-BS2
		1.5 kW	R88M-1L1K530T-B	R88M-1L1K530T-BS2
		2 kW	R88M-1L2K030T-B	R88M-1L2K030T-BS2
	3 kW	R88M-1L3K030T-B	R88M-1L3K030T-BS2	
	400 VAC	750 W	R88M-1L75030C-B	R88M-1L75030C-BS2
		1 kW	R88M-1L1K030C-B	R88M-1L1K030C-BS2
		1.5 kW	R88M-1L1K530C-B	R88M-1L1K530C-BS2
		2 kW	R88M-1L2K030C-B	R88M-1L2K030C-BS2
3 kW		R88M-1L3K030C-B	R88M-1L3K030C-BS2	

AC Servo System 1S-series

Specifications			Model	
			With oil seal	
			Straight shaft	With key and tap
Without brake	100 VAC	100 W	R88M-1M10030S-O	R88M-1M10030S-OS2
		200 W	R88M-1M20030S-O	R88M-1M20030S-OS2
		400 W	R88M-1M40030S-O	R88M-1M40030S-OS2
	200 VAC	100 W	R88M-1M10030T-O	R88M-1M10030T-OS2
		200 W	R88M-1M20030T-O	R88M-1M20030T-OS2
		400 W	R88M-1M40030T-O	R88M-1M40030T-OS2
		750 W	R88M-1M75030T-O	R88M-1M75030T-OS2
		1 kW	R88M-1L1K030T-O	R88M-1L1K030T-OS2
		1.5 kW	R88M-1L1K530T-O	R88M-1L1K530T-OS2
	400 VAC	2 kW	R88M-1L2K030T-O	R88M-1L2K030T-OS2
		3 kW	R88M-1L3K030T-O	R88M-1L3K030T-OS2
		750 W	R88M-1L75030C-O	R88M-1L75030C-OS2
1 kW		R88M-1L1K030C-O	R88M-1L1K030C-OS2	
1.5 kW		R88M-1L1K530C-O	R88M-1L1K530C-OS2	
With brake	100 VAC	100 W	R88M-1M10030S-BO	R88M-1M10030S-BOS2
		200 W	R88M-1M20030S-BO	R88M-1M20030S-BOS2
		400 W	R88M-1M40030S-BO	R88M-1M40030S-BOS2
	200 VAC	100 W	R88M-1M10030T-BO	R88M-1M10030T-BOS2
		200W	R88M-1M20030T-BO	R88M-1M20030T-BOS2
		400 W	R88M-1M40030T-BO	R88M-1M40030T-BOS2
		750 W	R88M-1M75030T-BO	R88M-1M75030T-BOS2
		1 kW	R88M-1L1K030T-BO	R88M-1L1K030T-BOS2
		1.5 kW	R88M-1L1K530T-BO	R88M-1L1K530T-BOS2
	400 VAC	2 kW	R88M-1L2K030T-BO	R88M-1L2K030T-BOS2
		3 kW	R88M-1L3K030T-BO	R88M-1L3K030T-BOS2
		750 W	R88M-1L75030C-BO	R88M-1L75030C-BOS2
1 kW		R88M-1L1K030C-BO	R88M-1L1K030C-BOS2	
1.5 kW		R88M-1L1K530C-BO	R88M-1L1K530C-BOS2	
		2 kW	R88M-1L2K030C-BO	R88M-1L2K030C-BOS2
		3 kW	R88M-1L3K030C-BO	R88M-1L3K030C-BOS2

● 2,000-r/min Servomotors

Specifications			Model		
			Without oil seal		
			Straight shaft	With key and tap	
Without brake	200 VAC	1 kW	R88M-1M1K020T	R88M-1M1K020T-S2	
		1.5 kW	R88M-1M1K520T	R88M-1M1K520T-S2	
		2 kW	R88M-1M2K020T	R88M-1M2K020T-S2	
		3 kW	R88M-1M3K020T	R88M-1M3K020T-S2	
	400 VAC	400 W	R88M-1M40020C	R88M-1M40020C-S2	
		600 W	R88M-1M60020C	R88M-1M60020C-S2	
		1 kW	R88M-1M1K020C	R88M-1M1K020C-S2	
		1.5 kW	R88M-1M1K520C	R88M-1M1K520C-S2	
		2 kW	R88M-1M2K020C	R88M-1M2K020C-S2	
		3 kW	R88M-1M3K020C	R88M-1M3K020C-S2	
	Witht brake	200 VAC	1 kW	R88M-1M1K020T-B	R88M-1M1K020T-BS2
			1.5 kW	R88M-1M1K520T-B	R88M-1M1K520T-BS2
2 kW			R88M-1M2K020T-B	R88M-1M2K020T-BS2	
3 kW			R88M-1M3K020T-B	R88M-1M3K020T-BS2	
400 VAC		400 W	R88M-1M40020C-B	R88M-1M40020C-BS2	
		600 W	R88M-1M60020C-B	R88M-1M60020C-BS2	
		1 kW	R88M-1M1K020C-B	R88M-1M1K020C-BS2	
		1.5 kW	R88M-1M1K520C-B	R88M-1M1K520C-BS2	
		2 kW	R88M-1M2K020C-B	R88M-1M2K020C-BS2	
		3 kW	R88M-1M3K020C-B	R88M-1M3K020C-BS2	

Specifications			Model	
			With oil seal	
			Straight shaft	With key and tap
Without brake	200 VAC	1 kW	R88M-1M1K020T-O	R88M-1M1K020T-OS2
		1.5 kW	R88M-1M1K520T-O	R88M-1M1K520T-OS2
		2 kW	R88M-1M2K020T-O	R88M-1M2K020T-OS2
		3 kW	R88M-1M3K020T-O	R88M-1M3K020T-OS2
	400 VAC	400 W	R88M-1M40020C-O	R88M-1M40020C-OS2
		600 W	R88M-1M60020C-O	R88M-1M60020C-OS2
		1 kW	R88M-1M1K020C-O	R88M-1M1K020C-OS2
		1.5 kW	R88M-1M1K520C-O	R88M-1M1K520C-OS2
		2 kW	R88M-1M2K020C-O	R88M-1M2K020C-OS2
		3 kW	R88M-1M3K020C-O	R88M-1M3K020C-OS2
With brake	200 VAC	1 kW	R88M-1M1K020T-BO	R88M-1M1K020T-BOS2
		1.5 kW	R88M-1M1K520T-BO	R88M-1M1K520T-BOS2
		2 kW	R88M-1M2K020T-BO	R88M-1M2K020T-BOS2
		3 kW	R88M-1M3K020T-BO	R88M-1M3K020T-BOS2
	400 VAC	400 W	R88M-1M40020C-BO	R88M-1M40020C-BOS2
		600 W	R88M-1M60020C-BO	R88M-1M60020C-BOS2
		1 kW	R88M-1M1K020C-BO	R88M-1M1K020C-BOS2
		1.5 kW	R88M-1M1K520C-BO	R88M-1M1K520C-BOS2
		2 kW	R88M-1M2K020C-BO	R88M-1M2K020C-BOS2
		3 kW	R88M-1M3K020C-BO	R88M-1M3K020C-BOS2

● 1,000-r/min Servomotors

Specifications			Model	
			Without oil seal	
			Straight shaft	With key and tap
Without brake	200 VAC	900 W	R88M-1M90010T	R88M-1M90010T-S2
		2 kW	R88M-1M2K010T	R88M-1M2K010T-S2
		3 kW	R88M-1M3K010T	R88M-1M3K010T-S2
	400 VAC	900 W	R88M-1M90010C	R88M-1M90010C-S2
		2 kW	R88M-1M2K010C	R88M-1M2K010C-S2
		3 kW	R88M-1M3K010C	R88M-1M3K010C-S2
With brake	200 VAC	900 W	R88M-1M90010T-B	R88M-1M90010T-BS2
		2 kW	R88M-1M2K010T-B	R88M-1M2K010T-BS2
		3 kW	R88M-1M3K010T-B	R88M-1M3K010T-BS2
	400 VAC	900 W	R88M-1M90010C-B	R88M-1M90010C-BS2
		2 kW	R88M-1M2K010C-B	R88M-1M2K010C-BS2
		3 kW	R88M-1M3K010C-B	R88M-1M3K010C-BS2

Specifications			Model	
			With oil seal	
			Straight shaft	With key and tap
Without brake	200 VAC	900 W	R88M-1M90010T-O	R88M-1M90010T-OS2
		2 kW	R88M-1M2K010T-O	R88M-1M2K010T-OS2
		3 kW	R88M-1M3K010T-O	R88M-1M3K010T-OS2
	400 VAC	900 W	R88M-1M90010C-O	R88M-1M90010C-OS2
		2 kW	R88M-1M2K010C-O	R88M-1M2K010C-OS2
		3 kW	R88M-1M3K010C-O	R88M-1M3K010C-OS2
With brake	200 VAC	900 W	R88M-1M90010T-BO	R88M-1M90010T-BOS2
		2 kW	R88M-1M2K010T-BO	R88M-1M2K010T-BOS2
		3 kW	R88M-1M3K010T-BO	R88M-1M3K010T-BOS2
	400 VAC	900 W	R88M-1M90010C-BO	R88M-1M90010C-BOS2
		2 kW	R88M-1M2K010C-BO	R88M-1M2K010C-BOS2
		3 kW	R88M-1M3K010C-BO	R88M-1M3K010C-BOS2

AC Servo System 1S-series

Decelerator (Backlash: 3 Arcminutes Max.)

● For 3,000-r/min Servomotors

Servomotor rated output	Reduction ratio	Model (Straight shaft) *
100 W	1/5	R88G-HPG11B05100B□
	1/11	R88G-HPG14A11100B□
	1/21	R88G-HPG14A21100B□
	1/33	R88G-HPG20A33100B□
	1/45	R88G-HPG20A45100B□
200 W	1/5	R88G-HPG14A05200B□
	1/11	R88G-HPG14A11200B□
	1/21	R88G-HPG20A21200B□
	1/33	R88G-HPG20A33200B□
400 W	1/45	R88G-HPG20A45200B□
	1/5	R88G-HPG14A05400B□
	1/11	R88G-HPG20A11400B□
	1/21	R88G-HPG20A21400B□
	1/33	R88G-HPG32A33400B□
750 W (200 V)	1/45	R88G-HPG32A45400B□
	1/5	R88G-HPG20A05750B□
	1/11	R88G-HPG20A11750B□
	1/21	R88G-HPG32A21750B□
	1/33	R88G-HPG32A33750B□
750 W (400 V)	1/45	R88G-HPG32A45750B□
	1/5	R88G-HPG32A052K0B□
	1/11	R88G-HPG32A112K0B□
	1/21	R88G-HPG32A211K5B□
	1/33	R88G-HPG32A33600SB□
1 kW	1/45	R88G-HPG50A451K5B□
	1/5	R88G-HPG32A052K0B□
	1/11	R88G-HPG32A112K0B□
	1/21	R88G-HPG32A211K5B□
	1/33	R88G-HPG50A332K0B□
1.5 kW	1/45	R88G-HPG50A451K5B□
	1/5	R88G-HPG32A052K0B□
	1/11	R88G-HPG32A112K0B□
	1/21	R88G-HPG32A211K5B□
	1/33	R88G-HPG50A332K0B□
2 kW	1/45	R88G-HPG50A451K5B□
	1/5	R88G-HPG32A052K0B□
	1/11	R88G-HPG32A112K0B□
	1/21	R88G-HPG50A212K0B□
3 kW	1/33	R88G-HPG50A332K0B□
	1/5	R88G-HPG32A053K0B□
	1/11	R88G-HPG50A113K0B□
3 kW	1/21	R88G-HPG50A213K0B□

* The standard shaft type is a straight shaft. A model with a key and tap is indicated with "J" at □ of the Decelerator model number.
e.g. R88G-HPG11B05100BJ

● For 2,000-r/min Servomotors

Servomotor rated output	Reduction ratio	Model (Straight shaft) *
400 W	1/5	R88G-HPG32A052K0B□
	1/11	R88G-HPG32A112K0B□
	1/21	R88G-HPG32A211K5B□
	1/33	R88G-HPG32A33600SB□
	1/45	R88G-HPG32A45400SB□
600 W	1/5	R88G-HPG32A052K0B□
	1/11	R88G-HPG32A112K0B□
	1/21	R88G-HPG32A211K5B□
	1/33	R88G-HPG32A33600SB□
	1/45	R88G-HPG50A451K5B□
1 kW	1/5	R88G-HPG32A053K0B□
	1/11	R88G-HPG32A112K0SB□
	1/21	R88G-HPG32A211K0SB□
	1/33	R88G-HPG50A332K0SB□
	1/45	R88G-HPG50A451K0SB□
1.5 kW	1/5	R88G-HPG32A053K0B□
	1/11	R88G-HPG32A112K0SB□
	1/21	R88G-HPG50A213K0B□
	1/33	R88G-HPG50A332K0SB□
	1/45	R88G-HPG50A451K0SB□
2 kW	1/5	R88G-HPG32A053K0B□
	1/11	R88G-HPG32A112K0SB□
	1/21	R88G-HPG50A213K0B□
	1/33	R88G-HPG50A332K0SB□
3 kW	1/5	R88G-HPG32A054K0B□
	1/11	R88G-HPG50A115K0B□
	1/21	R88G-HPG50A213K0SB□
	1/25	R88G-HPG65A253K0SB□

* The standard shaft type is a straight shaft. A model with a key and tap is indicated with "J" at □ of the Decelerator model number.
e.g. R88G-HPG11B05100BJ

● For 1,000-r/min Servomotors

Servomotor rated output	Reduction ratio	Model (Straight shaft) *
900 W	1/5	R88G-HPG32A05900TB□
	1/11	R88G-HPG32A11900TB□
	1/21	R88G-HPG50A21900TB□
	1/33	R88G-HPG50A33900TB□
2 kW	1/5	R88G-HPG32A052K0TB□
	1/11	R88G-HPG50A112K0TB□
	1/21	R88G-HPG50A212K0TB□
	1/25	R88G-HPG65A255K0SB□
3 kW	1/5	R88G-HPG50A055K0SB□
	1/11	R88G-HPG50A115K0SB□
	1/20	R88G-HPG65A205K0SB□
	1/25	R88G-HPG65A255K0SB□

* The standard shaft type is a straight shaft. A model with a key and tap is indicated with "J" at □ of the Decelerator model number.
e.g. R88G-HPG11B05100BJ

Decelerator (Backlash: 15 Arcminutes Max.)

● For 3,000-r/min Servomotors

Servomotor rated output	Reduction ratio	Model
100 W	1/5	R88G-VRXF05B100CJ
	1/9	R88G-VRXF09B100CJ
	1/15	R88G-VRXF15B100CJ
	1/25	R88G-VRXF25B100CJ
200 W	1/5	R88G-VRXF05B200CJ
	1/9	R88G-VRXF09C200CJ
	1/15	R88G-VRXF15C200CJ
	1/25	R88G-VRXF25C200CJ
400 W	1/5	R88G-VRXF05C400CJ
	1/9	R88G-VRXF09C400CJ
	1/15	R88G-VRXF15C400CJ
	1/25	R88G-VRXF25C400CJ
750 W (200 V)	1/5	R88G-VRXF05C750CJ
	1/9	R88G-VRXF09D750CJ
	1/15	R88G-VRXF15D750CJ
	1/25	R88G-VRXF25D750CJ

Cables and Peripheral Devices

Encoder Cables (Standard Cable)

Applicable Servomotor		Model	
100 V 200 V	3,000-r/min Servomotors of 100 W, 200 W, 400 W, and 750 W	3 m	R88A-CR1A003C
		5 m	R88A-CR1A005C
		10 m	R88A-CR1A010C
		15 m	R88A-CR1A015C
		20 m	R88A-CR1A020C
		30 m	R88A-CR1A030C
		40 m	R88A-CR1A040C
		50 m	R88A-CR1A050C
200 V 400 V	200 V: 3,000-r/min Servomotors of 1 kW or more 2,000-r/min Servomotors 1,000-r/min Servomotors 400 V: 3,000-r/min Servomotors 2,000-r/min Servomotors 1,000-r/min Servomotors	3 m	R88A-CR1B003N
		5 m	R88A-CR1B005N
		10 m	R88A-CR1B010N
		15 m	R88A-CR1B015N
		20 m	R88A-CR1B020N
		30 m	R88A-CR1B030N
		40 m	R88A-CR1B040N
		50 m	R88A-CR1B050N

Brake Cables (Standard Cable)

Applicable Servomotor		Model	
100 V 200 V	3,000-r/min Servomotors of 100 W, 200 W, 400 W, and 750 W	3 m	R88A-CA1A003B
		5 m	R88A-CA1A005B
		10 m	R88A-CA1A010B
		15 m	R88A-CA1A015B
		20 m	R88A-CA1A020B
		30 m	R88A-CA1A030B
		40 m	R88A-CA1A040B
		50 m	R88A-CA1A050B

Motor Power Cables (Standard Cable)

Applicable Servomotor		Without brake wire		With brake wire	
		Model		Model	
100 V 200 V	3,000-r/min Servomotors of 100 W, 200 W, 400 W, and 750 W	3 m	R88A-CA1A003S	---	
		5 m	R88A-CA1A005S	---	
		10 m	R88A-CA1A010S	---	
		15 m	R88A-CA1A015S	---	
		20 m	R88A-CA1A020S	---	
		30 m	R88A-CA1A030S	---	
		40 m	R88A-CA1A040S	---	
		50 m	R88A-CA1A050S	---	
200 V	3,000-r/min Servomotors of 1 kW 2,000-r/min Servomotors of 1 kW 1,000-r/min Servomotors of 900 W	3 m	R88A-CA1B003S	R88A-CA1B003B	
		5 m	R88A-CA1B005S	R88A-CA1B005B	
		10 m	R88A-CA1B010S	R88A-CA1B010B	
		15 m	R88A-CA1B015S	R88A-CA1B015B	
		20 m	R88A-CA1B020S	R88A-CA1B020B	
		30 m	R88A-CA1B030S	R88A-CA1B030B	
		40 m	R88A-CA1B040S	R88A-CA1B040B	
		50 m	R88A-CA1B050S	R88A-CA1B050B	

AC Servo System 1S-series

Applicable Servomotor		Without brake wire		With brake wire	
		Model		Model	
200 V	3,000-r/min Servomotors of 1.5 kW 2,000-r/min Servomotors of 1.5 kW	3 m	R88A-CA1C003S	R88A-CA1C003B	
		5 m	R88A-CA1C005S	R88A-CA1C005B	
		10 m	R88A-CA1C010S	R88A-CA1C010B	
		15 m	R88A-CA1C015S	R88A-CA1C015B	
		20 m	R88A-CA1C020S	R88A-CA1C020B	
		30 m	R88A-CA1C030S	R88A-CA1C030B	
		40 m	R88A-CA1C040S	R88A-CA1C040B	
400 V	3,000-r/min Servomotors of 750 W, 1 kW, 1.5 kW, and 2 kW 2,000-r/min Servomotors of 400 W, 600 W, 1 kW, 1.5 kW, and 2 kW 1,000-r/min Servomotors of 900 W	3 m	R88A-CA1C003S	R88A-CA1D003B	
		5 m	R88A-CA1C005S	R88A-CA1D005B	
		10 m	R88A-CA1C010S	R88A-CA1D010B	
		15 m	R88A-CA1C015S	R88A-CA1D015B	
		20 m	R88A-CA1C020S	R88A-CA1D020B	
		30 m	R88A-CA1C030S	R88A-CA1D030B	
		40 m	R88A-CA1C040S	R88A-CA1D040B	
200 V 400 V	3,000-r/min Servomotors of 2 kW (200 V) and 3 kW (200 V/400 V) 2,000-r/min Servomotors of 2 kW (200 V) and 3 kW (200 V/400 V) 1,000-r/min Servomotors of 2 kW (200 V/400 V) and 3 kW (400 V)	3 m	R88A-CA1E003S	R88A-CA1E003B	
		5 m	R88A-CA1E005S	R88A-CA1E005B	
		10 m	R88A-CA1E010S	R88A-CA1E010B	
		15 m	R88A-CA1E015S	R88A-CA1E015B	
		20 m	R88A-CA1E020S	R88A-CA1E020B	
		30 m	R88A-CA1E030S	R88A-CA1E030B	
		40 m	R88A-CA1E040S	R88A-CA1E040B	
200 V	1,000-r/min Servomotors of 3 kW	3 m	R88A-CA1F003S	R88A-CA1F003B	
		5 m	R88A-CA1F005S	R88A-CA1F005B	
		10 m	R88A-CA1F010S	R88A-CA1F010B	
		15 m	R88A-CA1F015S	R88A-CA1F015B	
		20 m	R88A-CA1F020S	R88A-CA1F020B	
		30 m	R88A-CA1F030S	R88A-CA1F030B	
		40 m	R88A-CA1F040S	R88A-CA1F040B	
		50 m	R88A-CA1F050S	R88A-CA1F050B	

Encoder Cables (Flexible Cable)

Applicable Servomotor		Model	
100 V 200 V	3,000-r/min Servomotors of 100 W, 200 W, 400 W, and 750 W	3 m	R88A-CR1A003CF
		5 m	R88A-CR1A005CF
		10 m	R88A-CR1A010CF
		15 m	R88A-CR1A015CF
		20 m	R88A-CR1A020CF
		30 m	R88A-CR1A030CF
		40 m	R88A-CR1A040CF
200 V 400 V	200 V: 3,000-r/min Servomotors of 1 kW or more For 2,000-r/min Servomotors For 1,000-r/min Servomotors 400 V: 3,000-r/min Servomotors 2,000-r/min Servomotors 1,000-r/min Servomotors	3 m	R88A-CR1B003NF
		5 m	R88A-CR1B005NF
		10 m	R88A-CR1B010NF
		15 m	R88A-CR1B015NF
		20 m	R88A-CR1B020NF
		30 m	R88A-CR1B030NF
		40 m	R88A-CR1B040NF
		50 m	R88A-CR1B050NF

Brake Cables (Flexible Cable)

Applicable Servomotor		Model	
100 V 200 V	3,000-r/min Servomotors of 100 W, 200 W, 400 W, and 750 W	3 m	R88A-CA1A003BF
		5 m	R88A-CA1A005BF
		10 m	R88A-CA1A010BF
		15 m	R88A-CA1A015BF
		20 m	R88A-CA1A020BF
		30 m	R88A-CA1A030BF
		40 m	R88A-CA1A040BF
		50 m	R88A-CA1A050BF

Motor Power Cables (Flexible Cable)





Applicable Servomotor		Without brake wire		With brake wire	
		Model	Model	Model	Model
100 V 200 V	3,000-r/min Servomotors of 100 W, 200 W, 400 W, and 750 W	3 m	R88A-CA1A003SF	---	
		5 m	R88A-CA1A005SF	---	
		10 m	R88A-CA1A010SF	---	
		15 m	R88A-CA1A015SF	---	
		20 m	R88A-CA1A020SF	---	
		30 m	R88A-CA1A030SF	---	
		40 m	R88A-CA1A040SF	---	
		50 m	R88A-CA1A050SF	---	
200 V	3,000-r/min Servomotors of 1 kW 2,000-r/min Servomotors of 1 kW 1,000-r/min Servomotors of 900 W	3 m	R88A-CA1B003SF	R88A-CA1B003BF	
		5 m	R88A-CA1B005SF	R88A-CA1B005BF	
		10 m	R88A-CA1B010SF	R88A-CA1B010BF	
		15 m	R88A-CA1B015SF	R88A-CA1B015BF	
		20 m	R88A-CA1B020SF	R88A-CA1B020BF	
		30 m	R88A-CA1B030SF	R88A-CA1B030BF	
		40 m	R88A-CA1B040SF	R88A-CA1B040BF	
		50 m	R88A-CA1B050SF	R88A-CA1B050BF	
200 V	3,000-r/min Servomotors of 1.5 kW 2,000-r/min Servomotors of 1.5 kW	3 m	R88A-CA1C003SF	R88A-CA1C003BF	
		5 m	R88A-CA1C005SF	R88A-CA1C005BF	
		10 m	R88A-CA1C010SF	R88A-CA1C010BF	
		15 m	R88A-CA1C015SF	R88A-CA1C015BF	
		20 m	R88A-CA1C020SF	R88A-CA1C020BF	
		30 m	R88A-CA1C030SF	R88A-CA1C030BF	
		40 m	R88A-CA1C040SF	R88A-CA1C040BF	
		50 m	R88A-CA1C050SF	R88A-CA1C050BF	
400 V	3,000-r/min Servomotors of 750 W, 1 kW, 1.5 kW, and 2 kW 2,000-r/min Servomotors of 400 W, 600 W, 1 kW, 1.5 kW, and 2 kW 1,000-r/min Servomotors of 900 W	3 m	R88A-CA1D003SF	R88A-CA1D003BF	
		5 m	R88A-CA1D005SF	R88A-CA1D005BF	
		10 m	R88A-CA1D010SF	R88A-CA1D010BF	
		15 m	R88A-CA1D015SF	R88A-CA1D015BF	
		20 m	R88A-CA1D020SF	R88A-CA1D020BF	
		30 m	R88A-CA1D030SF	R88A-CA1D030BF	
		40 m	R88A-CA1D040SF	R88A-CA1D040BF	
		50 m	R88A-CA1D050SF	R88A-CA1D050BF	
200 V 400 V	3,000-r/min Servomotors of 2 kW (200 V) and 3 kW (200 V/400 V) 2,000-r/min Servomotors of 2 kW (200 V) and 3 kW (200 V/400 V) 1,000-r/min Servomotors of 2 kW (200 V/400 V) and 3 kW (400 V)	3 m	R88A-CA1E003SF	R88A-CA1E003BF	
		5 m	R88A-CA1E005SF	R88A-CA1E005BF	
		10 m	R88A-CA1E010SF	R88A-CA1E010BF	
		15 m	R88A-CA1E015SF	R88A-CA1E015BF	
		20 m	R88A-CA1E020SF	R88A-CA1E020BF	
		30 m	R88A-CA1E030SF	R88A-CA1E030BF	
		40 m	R88A-CA1E040SF	R88A-CA1E040BF	
		50 m	R88A-CA1E050SF	R88A-CA1E050BF	
200 V	1,000-r/min Servomotors of 3 kW	3 m	R88A-CA1F003SF	R88A-CA1F003BF	
		5 m	R88A-CA1F005SF	R88A-CA1F005BF	
		10 m	R88A-CA1F010SF	R88A-CA1F010BF	
		15 m	R88A-CA1F015SF	R88A-CA1F015BF	
		20 m	R88A-CA1F020SF	R88A-CA1F020BF	
		30 m	R88A-CA1F030SF	R88A-CA1F030BF	
		40 m	R88A-CA1F040SF	R88A-CA1F040BF	
		50 m	R88A-CA1F050SF	R88A-CA1F050BF	

AC Servo System 1S-series

Recommended EtherCAT Communications Cable

Use a straight STP (shielded twisted-pair) cable of category 5 or higher with double shielding (braiding and aluminum foil tape) for EtherCAT.

Cabel with Connectors

Item	Appearance	Recommended manufacturer	Cable length [m]	Model
Cable with Connectors on Both Ends (RJ45/RJ45) Standard RJ45 plugs type *1 Wire gauge and number of pairs: AWG26, 4-pair cable Cable sheath material: LSZH *2 Cable color: Yellow *3		OMRON	0.3	XS6W-6LSZH8SS30CM-Y
			0.5	XS6W-6LSZH8SS50CM-Y
			1	XS6W-6LSZH8SS100CM-Y
			2	XS6W-6LSZH8SS200CM-Y
			3	XS6W-6LSZH8SS300CM-Y
			5	XS6W-6LSZH8SS500CM-Y
Cable with Connectors on Both Ends (RJ45/RJ45) Rugged RJ45 plugs type *1 Wire gauge and number of pairs: AWG22, 2-pair cable Cable color: Light blue		OMRON	0.3	XS5W-T421-AMD-K
			0.5	XS5W-T421-BMD-K
			1	XS5W-T421-CMD-K
			2	XS5W-T421-DMD-K
			5	XS5W-T421-GMD-K
			10	XS5W-T421-JMD-K
Cable with Connectors on Both Ends (M12 Straight/M12 Straight) Shield Strengthening Connector cable *4 M12/Smartclick Connectors Wire Gauge and Number of Pairs: AWG22, 2-pair cable Cable color: Black		OMRON	0.5	XS5W-T421-BM2-SS
			1	XS5W-T421-CM2-SS
			2	XS5W-T421-DM2-SS
			3	XS5W-T421-EM2-SS
			5	XS5W-T421-GM2-SS
			10	XS5W-T421-JM2-SS
Cable with Connectors on Both Ends (M12 Straight/RJ45) Shield Strengthening Connector cable *4 M12/Smartclick Connectors Rugged RJ45 plugs type Wire Gauge and Number of Pairs: AWG22, 2-pair cable Cable color: Black		OMRON	0.5	XS5W-T421-BMC-SS
			1	XS5W-T421-CMC-SS
			2	XS5W-T421-DMC-SS
			3	XS5W-T421-EMC-SS
			5	XS5W-T421-GMC-SS
			10	XS5W-T421-JMC-SS
Cable with Connectors on Both Ends (RJ45/RJ45) Rugged standard RJ45 plugs *5 Wire gauge and number of pairs: AWG22, 2-pair cable Cable color: Yellow		3M Japan Limited	0.25	3RHS4-1100-0.25M
			0.5	3RHS4-1100-0.5M
			1	3RHS4-1100-1M
			2	3RHS4-1100-2M
			5	3RHS4-1100-5M
			10	3RHS4-1100-10M

*1. Standard type cables length 0.2, 0.3, 0.5, 1, 1.5, 2, 3, 5, 7.5, 10, 15 and 20 m are available.

Rugged type cables length 0.3, 0.5, 1, 2, 3, 5, 10 and 15 m are available.

For details, refer to Cat.No.G019.

*2. The lineup features Low Smoke Zero Halogen cables for in-cabinet use and PUR cables for out-of-cabinet use. Although the LSZH cable is single shielded, its communications and noise characteristics meet the standards.

*3. Cables colors are available in blue, yellow, or Green.

*4. For details, contact your OMRON representative.

*5. Cables are available from 0.25 m to 100 m. Ask the manufacturer for details.

Cables/Connectors

Wire Gauge and Number of Pairs: AWG24, 4-pair Cable

Item	Appearance	Recommended manufacturer	Model
Cables	---	Hitachi Metals, Ltd.	NETSTAR-C5E SAB 0.5x4P *
	---	Kuramo Electric Co.	KETH-SB *
	---	SWCC Showa Cable Systems Co.	FAE-5004 *
RJ45 Connectors	---	Panduit Corporation	MPS588-C *

* We recommend you to use above cable and connector together.

Wire Gauge and Number of Pairs: AWG22, 2-pair Cable

Item	Appearance	Recommended manufacturer	Model
Cables	---	Kuramo Electric Co.	KETH-PSB-OMR *1
	---	JMACS Japan Co., Ltd.	PNET/B *1
RJ45 Assembly Connector		OMRON	XS6G-T421-1 *1
Cable	---	3M Japan Limited	79100-IE4P-F1-YE *2
RJ45 Assembly Connector	---		3R104-1110-000AM *2

*1. We recommend you to use above cable and connector together.

*2. We recommend you to use above cable and connector together.

Peripheral Connector Servo Drive Side Connectors

One of each of servo drive side connectors (except the encoder connector) are included with the R88D-1SN□-ECT AC Servo Drive. All connectors are also available separately for maintenance.

Name and applications	Model
Main circuit connector (CNA) *1 For R88D-1SN01L-ECT/-1SN02L-ECT/-1SN04L-ECT/-1SN01H-ECT/-1SN02H-ECT/-1SN04H-ECT/-1SN08H-ECT/-1SN10H-ECT	R88A-CN102P *4
Main circuit connector A (CNA) *2 For R88D-1SN15H-ECT/-1SN20H-ECT/-1SN30H-ECT/-1SN06F-ECT/-1SN10F-ECT/-1SN15F-ECT/-1SN20F-ECT/-1SN30F-ECT	R88A-CN103P *4
Main circuit connector B (CNB) *2 For R88D-1SN15H-ECT/-1SN20H-ECT/-1SN30H-ECT/-1SN06F-ECT/-1SN10F-ECT/-1SN15F-ECT/-1SN20F-ECT/-1SN30F-ECT	R88A-CN104P *4
Motor connector (CNC) For R88D-1SN01L-ECT/-1SN02L-ECT/-1SN04L-ECT/-1SN01H-ECT/-1SN02H-ECT/-1SN04H-ECT/-1SN08H-ECT/-1SN10H-ECT	R88A-CN101A *4
Motor connector (CNC) For R88D-1SN15H-ECT/-1SN20H-ECT/-1SN30H-ECT/-1SN06F-ECT/-1SN10F-ECT/-1SN15F-ECT/-1SN20F-ECT/-1SN30F-ECT	R88A-CN102A *4
Control power supply connector (CND) For R88D-1SN15H-ECT/-1SN20H-ECT/-1SN30H-ECT/-1SN06F-ECT/-1SN10F-ECT/-1SN15F-ECT/-1SN20F-ECT/-1SN30F-ECT	R88A-CN101P *4
Control I/O connector (CN1) *3	R88A-CN101C
Encoder connector (CN2)	R88A-CN101R
Brake interlock connector (CN12)	R88A-CN101B

*1. Two short-circuit wires are connected to the connector.

*2. One short-circuit wire is connected to the connector.

*3. Four short-circuit wires are connected to the connector.

*4. One opener is included.

Servomotor Side Connector

Name and applications		Model
Encoder connector	100 V, 200 V	For 3,000 r/min (100 to 750 W)
	100 V, 200 V	For 3,000 r/min (1 to 3 kW), 2,000 r/min, 1,000 r/min
	400 V	For 3,000 r/min, 2,000 r/min, 1,000 r/min
Power connector (For 750 W max.)		R88A-CN111A
Brake connector (For 750 W max.)		R88A-CN111B

External Regeneration Resistors

Applicable Servo Drive	Specifications	Model
R88D-1SN01L-ECT/-1SN02L-ECT	Regeneration process capacity: 24 W, 15 Ω	R88A-RR12015
R88D-1SN01H-ECT/-1SN02H-ECT	Regeneration process capacity: 24 W, 25 Ω	R88A-RR12025
R88D-1SN20H-ECT/-1SN30H-ECT	Regeneration process capacity: 60 W, 10 Ω	R88A-RR30010
R88D-1SN04L-ECT	Regeneration process capacity: 60 W, 12 Ω	R88A-RR30012
R88D-1SN01L-ECT/-1SN02L-ECT	Regeneration process capacity: 60 W, 15 Ω	R88A-RR30015
R88D-1SN15H-ECT	Regeneration process capacity: 60 W, 17 Ω	R88A-RR30017
R88D-1SN08H-ECT/-1SN10H-ECT/-1SN20F-ECT */-1SN30F-ECT *	Regeneration process capacity: 60 W, 20 Ω	R88A-RR30020
R88D-1SN01H-ECT/-1SN02H-ECT/-1SN04H-ECT	Regeneration process capacity: 60 W, 25 Ω	R88A-RR30025
R88D-1SN06F-ECT */-1SN10F-ECT */-1SN15F-ECT *	Regeneration process capacity: 60 W, 33 Ω	R88A-RR30033

* Use two series-connected External Regeneration Resistors for this model.

AC Servo System 1S-series

External Regeneration Resistance Unit

Applicable Servo Drive	Specifications	Model
R88D-1SN20H-ECT/-1SN30H-ECT	Regeneration process capacity: 640 W, 10 Ω	R88A-RR1K610
R88D-1SN15H-ECT	Regeneration process capacity: 640 W, 17 Ω	R88A-RR1K617
R88D-1SN08H-ECT/-1SN10H-ECT/-1SN20F-ECT */ -1SN30F-ECT *	Regeneration process capacity: 640 W, 20 Ω	R88A-RR1K620
R88D-1SN20F-ECT/-1SN30F-ECT	Regeneration process capacity: 640 W, 40 Ω	R88A-RR1K640
R88D-1SN06F-ECT/-1SN10F-ECT/-1SN15F-ECT	Regeneration process capacity: 640 W, 66 Ω	R88A-RR1K666

* Use two series-connected External Regeneration Resistance Units for this model.

Reactor

Applicable Servomotor	Model
R88D-1SN01L-ECT/-1SN01H-ECT/-1SN02H-ECT	R88A-PD2002
R88D-1SN02L-ECT/-1SN04H-ECT	R88A-PD2004
R88D-1SN04L-ECT/-1SN08H-ECT	R88A-PD2007
R88D-1SN10H-ECT/-1SN15H-ECT	R88A-PD2015
R88D-1SN20H-ECT	R88A-PD2022
R88D-1SN30H-ECT	R88A-PD2037
R88D-1SN06F-ECT	R88A-PD4007
R88D-1SN10F-ECT/-1SN15F-ECT	R88A-PD4015
R88D-1SN20F-ECT	R88A-PD4022
R88D-1SN30F-ECT	R88A-PD4037

Footprint-type Noise Filter

Applicable Servo Drive	Model
R88D-1SN01L-ECT/-1SN01H-ECT/-1SN02H-ECT (Single-phase input)	R88A-FI1S103
R88D-1SN02L-ECT/-1SN04H-ECT (Single-phase input)	R88A-FI1S105
R88D-1SN04L-ECT/-1SN08H-ECT (Single-phase input)	R88A-FI1S109
R88D-1SN15H-ECT (Single-phase input)	R88A-FI1S116
R88D-1SN01H-ECT/-1SN02H-ECT (3-phase input)	R88A-FI1S202
	R88A-FI1S203
R88D-1SN04H-ECT (3-phase input)	R88A-FI1S203
R88D-1SN08H-ECT (3-phase input)/-1SN10H-ECT	R88A-FI1S208
R88D-1SN15H-ECT (3-phase input)/-1SN20H-ECT/-1SN30H-ECT	R88A-FI1S216
R88D-1SN06F-ECT/-1SN10F-ECT-1SN15F-ECT/-1SN20F-ECT/-1SN30F-ECT	R88A-FI1S309

Software

Automation Software Sysmac Studio

Please purchase a DVD and required number of licenses the first time you purchase the Sysmac Studio. DVDs and licenses are available individually. Each model of licenses does not include any DVD.

Product name	Specifications	Number of licenses	Media	Model
Sysmac Studio Standard Edition Ver.1.□□ *1	The Sysmac Studio is the software that provides an integrated environment for setting, programming, debugging and maintenance of machine automation controllers including the NJ/NX-series CPU Units, NY-series Industrial PC, EtherCat Slave, and the HMI.	---	DVD	SYSMAC-SE200D
	Sysmac Studio runs on the following OS. Windows 7 (32-bit/64-bit version)/Windows 8 (32-bit/64-bit version)/ Windows 8.1 (32-bit/64-bit version)/Windows 10 (32-bit/64-bit version)	1 license *2	---	SYSMAC-SE201L
	The Sysmac Studio Standard Edition DVD includes Support Software to set up EtherNet/IP Units, DeviceNet slaves, Serial Communications Units, and Support Software for creating screens on HMIs (CX-Designer). For details, refer to your OMRON website.			
Sysmac Studio Drive Edition Ver.1.□□	Sysmac Studio Drive Edition is a limited license that provides selected functions required for 1S/G5 series Servo settings. This product is a license only. You need the Sysmac Studio Standard Edition DVD media to install it. With Drive Edition, you can use only the setup functions for 1S, G5-series Servo System	1 license	---	SYSMAC-DE001L

*1 The 1S series is supported by Sysmac Studio version 1.16 or higher.

*2 Multi licenses are available for the Sysmac Studio (3, 10, 30, or 50 licenses).

Collections of software functional components

Sysmac Library

Sysmac Library is POU Libraries (Function Block and Function) provided for NJ/NX-series Controller.

Please download it from following URL and install to Sysmac Studio.

http://www.ia.omron.com/sysmac_library/

Product	Features	Model
EtherCAT 1S Series Library	The EtherCAT 1S Series Library is used to initialize the absolute encoder, back up and restore the parameters for an OMRON 1S-series Servo Drive with built-in EtherCAT communications. You can use this library to reduce manpower of programming when implementing the processing for a Servo Drive.	SYSMAC-XR011

AC Servo System 1S-series

Combination table

Servo Drive and Servomotor Combinations

The following tables show the possible combinations of 1S-series Servo Drives and Servomotors.

The Servomotors and Servo Drives can only be used in the listed combinations. "□" at the end of the motor model number is for options, such as the shaft type and brake.

3,000-r/min Servomotors and Servo Drives

Main circuit power supply voltage	Servomotor rated output	Servomotor	Servo Drive
Single-phase 100 VAC	100 W	R88M-1M10030S-□	R88D-1SN01L-ECT
	200 W	R88M-1M20030S-□	R88D-1SN02L-ECT
	400 W	R88M-1M40030S-□	R88D-1SN04L-ECT
Single-phase/3-phase 200 VAC	100 W	R88M-1M10030T-□	R88D-1SN01H-ECT
	200 W	R88M-1M20030T-□	R88D-1SN02H-ECT
	400 W	R88M-1M40030T-□	R88D-1SN04H-ECT
	750 W	R88M-1M75030T-□	R88D-1SN08H-ECT
	1.5 kW	R88M-1L1K530T-□	R88D-1SN15H-ECT
3-phase 200 VAC	1 kW	R88M-1L1K030T-□	R88D-1SN10H-ECT
	2 kW	R88M-1L2K030T-□	R88D-1SN20H-ECT
	3 kW	R88M-1L3K030T-□	R88D-1SN30H-ECT
3-phase 400 VAC	750 W	R88M-1L75030C-□	R88D-1SN10F-ECT
	1 kW	R88M-1L1K030C-□	R88D-1SN10F-ECT
	1.5 kW	R88M-1L1K530C-□	R88D-1SN15F-ECT
	2 kW	R88M-1L2K030C-□	R88D-1SN20F-ECT
	3 kW	R88M-1L3K030C-□	R88D-1SN30F-ECT

2,000-r/min Servomotors and Servo Drives

Main circuit power supply voltage	Servomotor rated output	Servomotor	Servo Drive
Single-phase/3-phase 200 VAC	1.5 kW	R88M-1M1K520T-□	R88D-1SN15H-ECT
3-phase 200 VAC	1 kW	R88M-1M1K020T-□	R88D-1SN10H-ECT
	2 kW	R88M-1M2K020T-□	R88D-1SN20H-ECT
	3 kW	R88M-1M3K020T-□	R88D-1SN30H-ECT
3-phase 400 VAC	400 W	R88M-1M40020C-□	R88D-1SN06F-ECT
	600 W	R88M-1M60020C-□	R88D-1SN06F-ECT
	1 kW	R88M-1M1K020C-□	R88D-1SN10F-ECT
	1.5 kW	R88M-1M1K520C-□	R88D-1SN15F-ECT
	2 kW	R88M-1M2K020C-□	R88D-1SN20F-ECT
	3 kW	R88M-1M3K020C-□	R88D-1SN30F-ECT

1,000-r/min Servomotors and Servo Drives

Main circuit power supply voltage	Servomotor rated output	Servomotor	Servo Drive
3-phase 200 VAC	900 W	R88M-1M90010T-□	R88D-1SN10H-ECT
	2 kW	R88M-1M2K010T-□	R88D-1SN20H-ECT
	3 kW	R88M-1M3K010T-□	R88D-1SN30H-ECT
3-phase 400 VAC	900 W	R88M-1M90010C-□	R88D-1SN10F-ECT
	2 kW	R88M-1M2K010C-□	R88D-1SN20F-ECT
	3 kW	R88M-1M3K010C-□	R88D-1SN30F-ECT

Servomotor and Decelerator Combinations

3,000-r/min Servomotors and Decelerators (Backlash:3 Arcminutes Max.)

Servomotor models *	1/5	1/11	1/21	1/33	1/45
R88M-1M10030□	R88G-HPG 11B05100B□	R88G-HPG 14A11100B□	R88G-HPG 14A21100B□	R88G-HPG 20A33100B□	R88G-HPG 20A45100B□
R88M-1M20030□	R88G-HPG 14A05200B□	R88G-HPG 14A11200B□	R88G-HPG 20A21200B□	R88G-HPG 20A33200B□	R88G-HPG 20A45200B□
R88M-1M40030□	R88G-HPG 14A05400B□	R88G-HPG 20A11400B□	R88G-HPG 20A21400B□	R88G-HPG 32A33400B□	R88G-HPG 32A45400B□
R88M-1M75030□ (200 VAC)	R88G-HPG 20A05750B□	R88G-HPG 20A11750B□	R88G-HPG 32A21750B□	R88G-HPG 32A33750B□	R88G-HPG 32A45750B□
R88M-1L75030□ (400 VAC)	R88G-HPG 32A052K0B□	R88G-HPG 32A112K0B□	R88G-HPG 32A211K5B□	R88G-HPG 32A33600SB□	R88G-HPG 50A451K5B□
R88M-1L1K030□			R88G-HPG 50A212K0B□	---	
R88M-1L1K530□					---
R88M-1L2K030□			---		
R88M-1L3K030□	R88G-HPG 32A053K0B□	R88G-HPG 50A113K0B□	R88G-HPG 50A213K0B□	---	---

* You cannot use a Servomotor with a key and tap (model numbers with -S2 at the end) in combination with a Decelerator.

2,000-r/min Servomotors and Decelerators (Backlash:3 Arcminutes Max.)

Servomotor models *	1/5	1/11	1/21	1/25	1/33	1/45
R88M-1M40020□ (400VAC)	R88G-HPG 32A052K0B□	R88G-HPG 32A112K0B□	R88G-HPG 32A211K5B□	---	R88G-HPG 32A33600SB□	R88G-HPG 32A45400SB□
R88M-1M60020□ (400VAC)			---	---		R88G-HPG 50A451K5B□
R88M-1M1K020□	R88G-HPG 32A053K0B□	R88G-HPG 32A112K0SB□	R88G-HPG 32A211K0SB□	---	R88G-HPG 50A332K0SB□	R88G-HPG 50A451K0SB□
R88M-1M1K520□			R88G-HPG 50A213K0B□	---		---
R88M-1M2K020□			---	---		
R88M-1M3K020□	R88G-HPG 32A054K0B□	R88G-HPG 50A115K0B□	R88G-HPG 50A213K0SB□	R88G-HPG 65A253K0SB□	---	---

* You cannot use a Servomotor with a key and tap (model numbers with -S2 at the end) in combination with a Decelerator.

1,000-r/min Servomotors and Decelerators (Backlash:3 Arcminutes Max.)

Servomotor models *	1/5	1/11	1/21	1/25	1/33	1/45
R88M-1M90010□	R88G-HPG 32A05900TB□	R88G-HPG 32A11900TB□	---	R88G-HPG 50A21900TB□	---	R88G-HPG 50A33900TB□
R88M-1M2K010□	R88G-HPG 32A052K0TB□	R88G-HPG 50A112K0TB□	---	R88G-HPG 50A212K0TB□	R88G-HPG 65A255K0SB□	---
R88M-1M3K020□	R88G-HPG 50A055K0SB□	R88G-HPG 50A115K0SB□	R88G-HPG 65A205K0SB□	---		---

* You cannot use a Servomotor with a key and tap (model numbers with -S2 at the end) in combination with a Decelerator.

3,000-r/min Servomotors and Decelerators (Backlash:15 Arcminutes Max.)

Servomotor models *	Reduction ratio			
	1/5	1/9	1/15	1/25
R88M-1M10030□	R88G-VRXF05B100CJ	R88G-VRXF09B100CJ	R88G-VRXF15B100CJ	R88G-VRXF25B100CJ
R88M-1M20030□	R88G-VRXF05B200CJ	R88G-VRXF09C200CJ	R88G-VRXF15C200CJ	R88G-VRXF25C200CJ
R88M-1M40030□	R88G-VRXF05C400CJ	R88G-VRXF09C400CJ	R88G-VRXF15C400CJ	R88G-VRXF25C400CJ
R88M-1M75030□ (200 VAC)	R88G-VRXF05C750CJ	R88G-VRXF09D750CJ	R88G-VRXF15D750CJ	R88G-VRXF25D750CJ

* You cannot use a Servomotor with a key and tap (model numbers with -S2 at the end) in combination with a Decelerator.

AC Servo System 1S-series

Cable Connection Configuration

Encoder Cables

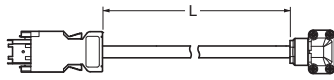
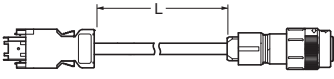
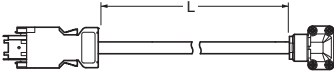
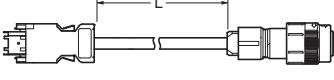
Connected to	Model	Connection configuration and external dimensions [mm]	
100 V and 200 V: 3,000-r/min Servomotors of 100 W, 200 W, 400 W, and 750 W	Standard Cable R88A-CR1A□□□C The empty boxes in the model number are for the cable length. (3 to 20 m: 5.3 dia. 30 to 50 m: 6.0 dia.)	Servo Drive side connector Connector model Receptacle: 3E206-0100KV (3M) Shell kit: 3E306-3200-008 (3M)	 Servomotor side connector Angle clamp model JN6FR07SM1 (Japan Aviation Electronics) Connector pin model LY10-C1-A1-10000 (Japan Aviation Electronics)
200 V: 3,000-r/min Servomotors of 1 kW, 2,000-r/min Servomotors, and 1,000-r/min Servomotors 400 V: 3,000-r/min Servomotors, 2,000-r/min Servomotors, and 1,000-r/min Servomotors	Standard Cable R88A-CR1B□□□N The empty boxes in the model number are for the cable length. (6.0 dia.)	Servo Drive side connector Connector model Receptacle: 3E206-0100KV (3M) Shell kit: 3E306-3200-008 (3M)	 Servomotor side connector Straight plug model JN2DS10SL1-R (Japan Aviation Electronics) Contact model JN1-22-22S-10000 (Japan Aviation Electronics)
100 V and 200 V: 3,000-r/min Servomotors of 100 W, 200 W, 400 W and 750 W	Flexible Cable R88A-CR1A□□□CF The empty boxes in the model number are for the cable length. (3 to 20 m: 5.3 dia. 30 to 50 m: 6.0 dia.)	Servo Drive side connector Connector model Receptacle: 3E206-0100KV (3M) Shell kit: 3E306-3200-008 (3M)	 Servomotor side connector Angle clamp model JN6FR07SM1 Connector pin model LY10-C1-A1-10000 (Japan Aviation Electronics)
200 V: 3,000-r/min Servomotors of 1 kW, 2,000-r/min Servomotors, and 1,000-r/min Servomotors 400 V: 3,000-r/min Servomotors, 2,000-r/min Servomotors, and 1,000-r/min Servomotors	Flexible Cable R88A-CR1B□□□NF The empty boxes in the model number are for the cable length. (6.0 dia.)	Servo Drive side connector Connector model Receptacle: 3E206-0100KV (3M) Shell kit: 3E306-3200-008 (3M)	 Servomotor side connector Straight plug model JN2DS10SL1-R (Japan Aviation Electronics) Contact model JN1-22-22S-10000 (Japan Aviation Electronics)

Note: Cable length: 3 m, 5 m, 10 m, 15 m, 20 m, 30 m, 40 m, 50 m
The empty boxes in the model number are put as follows: 3 m = 003, 5 m = 005, 10 m = 010.

Power Cables without Brake Wire

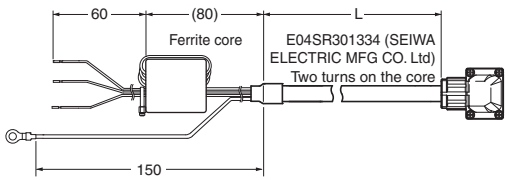
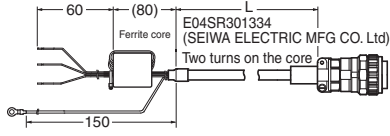
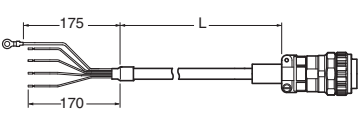
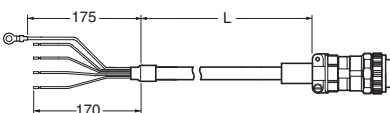
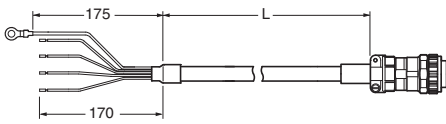
Connected to	Model	Connection configuration and external dimensions [mm]	
100 V and 200 V: 3,000-r/min Servomotors of 100 W, 200 W, 400 W, and 750 W	Standard Cable R88A-CA1A□□□S The empty boxes in the model number are for the cable length. (6.8 dia.)	 Ferrite core E04SR301334 (SEIWA ELECTRIC MFG CO. Ltd) Two turns on the core	Note: Use the R88A- CN111A Power Connector/Socket Contact (Omron) for this cable.
200 V: 3,000-r/min Servomotors of 1 kW, 2,000-r/min Servomotors of 1 kW, and 1,000-r/min Servomotors of 900 W	Standard Cable R88A-CA1B□□□S The empty boxes in the model number are for the cable length. (10.8 dia.)	 Ferrite core E04SR301334 (SEIWA ELECTRIC MFG CO. Ltd) Two turns on the core	Servomotor side connector Connector JL10-6A20-4SE-EB (Japan Aviation Electronics) Clamp JL04-2022CK(12)-R (Japan Aviation Electronics)
200 V: 3,000-r/min Servomotors of 1.5 kW and 2,000-r/min Servomotors of 1.5 kW 400 V: 3,000-r/min Servomotors of 750 W, 1 kW, 1.5 kW, and 2 kW 2,000-r/min Servomotors of 400 W, 600 W, 1 kW, 1.5 kW, and 2 kW 1,000-r/min Servomotors of 900 W	Standard Cable R88A-CA1C□□□S The empty boxes in the model number are for the cable length. (10.8 dia.)		Servomotor side connector Connector JL10-6A20-4SE-EB (Japan Aviation Electronics) Clamp JL04-2022CK(12)-R (Japan Aviation Electronics)
200 V: 3,000-r/min Servomotors of 2 kW and 3 kW 2,000-r/min Servomotors of 2 kW and 3 kW 1,000-r/min Servomotors of 2 kW 400 V: 3,000-r/min Servomotors of 3 kW 2,000-r/min Servomotors of 3 kW 1,000-r/min Servomotors of 2 kW and 3 kW	Standard Cable R88A-CA1E□□□S The empty boxes in the model number are for the cable length. (12.0 dia.)		Servomotor side connector Connector JL10-6A22-22SE-EB (Japan Aviation Electronics) Clamp JL04-2022CK(12)-R (Japan Aviation Electronics)
200 V: 1,000-r/min Servomotors of 3 kW	Standard Cable R88A-CA1F□□□S The empty boxes in the model number are for the cable length. (14.5 dia.)		Servomotor side connector Connector JL10-6A22-22SE-EB (Japan Aviation Electronics) Clamp JL04-2022CK(14)-R (Japan Aviation Electronics)

Connected to	Model	Connection configuration and external dimensions [mm]	
100 V and 200 V: 3,000-r/min Servomotors of 100 W, 200 W, 400 W, and 750 W	Flexible Cable R88A-CA1A□□□SF The empty boxes in the model number are for the cable length. (6.8 dia.)		Note: Use the R88A-CN111A Power Connector/Socket Contact (Omron) for this cable.
200 V: 3,000-r/min Servomotors of 1 kW, 2,000-r/min Servomotors of 1 kW, and 1,000-r/min Servomotors of 900 W	Flexible Cable R88A-CA1B□□□SF The empty boxes in the model number are for the cable length. (10.8 dia.)		Servomotor side connector Connector JL10-6A20-4SE-EB (Japan Aviation Electronics) Clamp JL04-2022CK(12)-R (Japan Aviation Electronics)
200 V: 3,000-r/min Servomotors of 1.5 kW 2,000-r/min Servomotors of 1.5 kW 400 V: 3,000-r/min Servomotors of 750 W, 1 kW, 1.5 kW, and 2 kW 2,000-r/min Servomotors of 400 W, 600 W, 1 kW, 1.5 kW, and 2 kW 1,000-r/min Servomotors of 900 W	Flexible Cable R88A-CA1C□□□SF The empty boxes in the model number are for the cable length. (10.8 dia.)		Servomotor side connector Connector JL10-6A20-4SE-EB (Japan Aviation Electronics) Clamp JL04-2022CK(12)-R (Japan Aviation Electronics)
200 V: 3,000-r/min Servomotors of 2 kW and 3 kW 2,000-r/min Servomotors of 2 kW and 3 kW 1,000-r/min Servomotors of 2 kW 400 V: 3,000-r/min Servomotors of 3 kW 2,000-r/min Servomotors of 3 kW 1,000-r/min Servomotors of 2 kW and 3 kW	Flexible Cable R88A-CA1E□□□SF The empty boxes in the model number are for the cable length. (12.0 dia.)		Servomotor side connector Connector JL10-6A22-22SE-EB (Japan Aviation Electronics) Clamp JL04-2022CK(12)-R (Japan Aviation Electronics)
200 V: 1,000-r/min Servomotors of 3 kW	Flexible Cable R88A-CA1F□□□SF The empty boxes in the model number are for the cable length. (14.5 dia.)		Servomotor side connector Connector JL10-6A22-22SE-EB (Japan Aviation Electronics) Clamp JL04-2022CK(14)-R (Japan Aviation Electronics)

Note: Cable length: 3 m, 5 m, 10 m, 15 m, 20 m, 30 m, 40 m, 50 m
The empty boxes in the model number are put as follows: 3 m = 003, 5 m = 005, 10 m = 010.

Power Cables with Brake Wire

Connected to	Model	Connection configuration and external dimensions [mm]	
200 V: 3,000-r/min Servomotors of 1 kW 2,000-r/min Servomotors of 1 kW 1,000-r/min Servomotors of 900 W	Standard Cable R88A-CA1B□□□B The empty boxes in the model number are for the cable length. (12.5 dia.)		Servomotor side connector Connector JN6FS05S.J2 (Japan Aviation Electronics) Socket contact ST-JN6-S-C1B-2500 (Japan Aviation Electronics)
200 V: 3,000-r/min Servomotors of 1.5 kW 2,000-r/min Servomotors of 1.5 kW	Standard Cable R88A-CA1C□□□B The empty boxes in the model number are for the cable length. (12.5 dia.)		Servomotor side connector Connector JL10-6A20-18SE-EB (Japan Aviation Electronics) Clamp JL04-2022CK(12)-R (Japan Aviation Electronics)
400 V: 3,000-r/min Servomotors of 750 W, 1 kW, 1.5 kW, and 2 kW 2,000-r/min Servomotors of 400 W, 600 W, 1 kW, 1.5 kW, and 2 kW 1,000-r/min Servomotors of 900 W	Standard Cable R88A-CA1D□□□B The empty boxes in the model number are for the cable length. (12.5 dia.)		Servomotor side connector Connector JL10-6A24-11SE-EB (Japan Aviation Electronics) Clamp JL04-2428CK(14)-R (Japan Aviation Electronics)

AC Servo System 1S-series

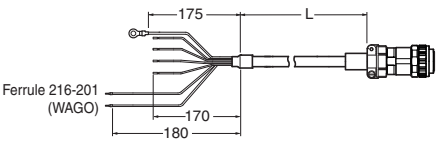
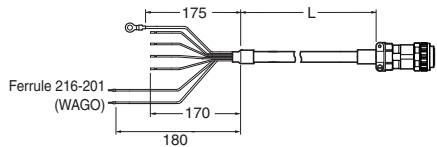
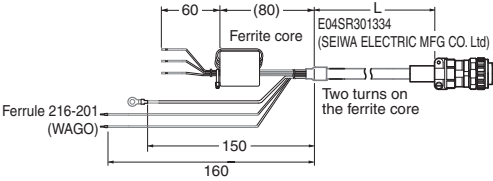
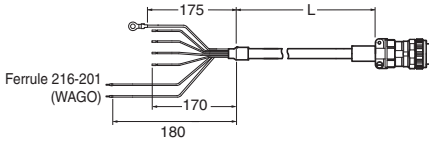
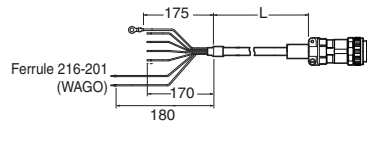
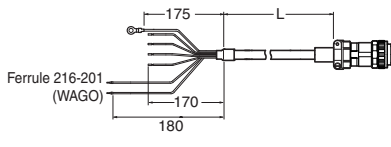
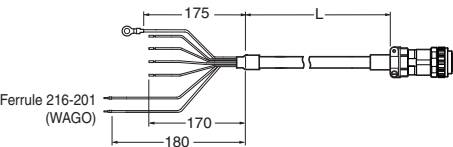
Connected to	Model	Connection configuration and external dimensions [mm]
200 V: 3,000-r/min Servomotors of 2 kW and 3 kW 2,000-r/min Servomotors of 2 kW and 3 kW 1,000-r/min Servomotors of 2 kW 400 V: 3,000-r/min Servomotors of 3 kW 2,000-r/min Servomotors of 3 kW 1,000-r/min Servomotors of 2 kW and 3 kW	Standard Cable R88A-CA1E□□□B The empty boxes in the model number are for the cable length. (14.0 dia.)	 <p>Servomotor side connector Connector JL10-6A24-11SE-EB (Japan Aviation Electronics) Clamp JL04-2428CK(14)-R (Japan Aviation Electronics)</p>
200 V: 1,000-r/min Servomotors of 3 kW	Standard Cable R88A-CA1F□□□B The empty boxes in the model number are for the cable length. (17.0 dia.)	 <p>Servomotor side connector Connector JN6FS05SJ2 (Japan Aviation Electronics) Socket contact ST-JN5-S-C1B-2500 (Japan Aviation Electronics)</p>
200 V: 3,000-r/min Servomotors of 1 kW 2,000-r/min Servomotors of 1 kW 1,000-r/min Servomotors of 900 W	Flexible Cable R88A-CA1B□□□BF The empty boxes in the model number are for the cable length. (12.5 dia.)	 <p>Servomotor side connector Connector JL10-6A20-18SE-EB (Japan Aviation Electronics) Clamp JL04-2022CK(14)-R (Japan Aviation Electronics)</p>
200 V: 3,000-r/min Servomotors of 1.5 kW 2,000-r/min Servomotors of 1.5 kW	Flexible Cable R88A-CA1C□□□BF The empty boxes in the model number are for the cable length. (12.5 dia.)	 <p>Servomotor side connector Connector JL10-6A20-18SE-EB (Japan Aviation Electronics) Clamp JL04-2022CK(12)-R (Japan Aviation Electronics)</p>
400 V: 3,000-r/min Servomotors of 750 W, 1 kW, 1.5 kW, and 2 kW 2,000-r/min Servomotors of 400 W, 600 W, 1 kW, 1.5 kW, and 2 kW 1,000-r/min Servomotors of 900 W	Flexible Cable R88A-CA1D□□□BF The empty boxes in the model number are for the cable length. (12.5 dia.)	 <p>Servomotor side connector Connector JL10-6A24-11SE-EB (Japan Aviation Electronics) Clamp JL04-2428CK(14)-R (Japan Aviation Electronics)</p>
200 V: 3,000-r/min Servomotors of 2 kW and 3 kW 2,000-r/min Servomotors of 2 kW and 3 kW 1,000-r/min Servomotors of 2 kW 400 V: 3,000-r/min Servomotors of 3 kW 2,000-r/min Servomotors of 3 kW 1,000-r/min Servomotors of 2 kW and 3 kW	Flexible Cable R88A-CA1E□□□BF The empty boxes in the model number are for the cable length. (14.2 dia.)	 <p>Servomotor side connector Connector JL10-6A24-11SE-EB (Japan Aviation Electronics) Clamp JL04-2428CK(14)-R (Japan Aviation Electronics)</p>
200 V: 1,000-r/min Servomotors of 3 kW	Flexible Cable R88A-CA1F□□□BF The empty boxes in the model number are for the cable length. (17.0 dia.)	 <p>Servomotor side connector Connector JL10-6A24-11SE-EB (Japan Aviation Electronics) Clamp JL04-2428CK(17)-R (Japan Aviation Electronics)</p>

Note: Cable length: 3 m, 5 m, 10 m, 15 m, 20 m, 30 m, 40 m, 50 m
 The empty boxes in the model number are put as follows: 3 m = 003, 5 m = 005, 10 m = 010.

Brake Cables

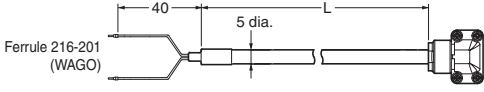
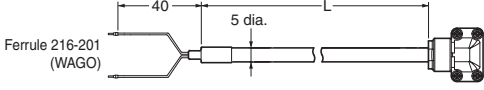
Connected to	Model	Connection configuration and external dimensions [mm]
100 V and 200 V: 3,000-r/min Servomotors of 100 W, 200 W, 400 W, and 750 W	Standard Cable R88A-CA1A□□□□B The empty boxes in the model number are for the cable length. (5.0 dia.)	 <p>Servomotor side connector Connector JN6FR02SM1 (Japan Aviation Electronics) Socket contact LY10-C1-A1-10000 (Japan Aviation Electronics)</p>
100 V and 200 V: 3,000-r/min Servomotors of 100 W, 200 W, 400 W, and 750 W	Flexible Cable R88A-CA1A□□□□BF The empty boxes in the model number are for the cable length. (5.0 dia.)	 <p>Servomotor side connector Connector JN6FR02SM1 (Japan Aviation Electronics) Socket contact LY10-C1-A1-10000 (Japan Aviation Electronics)</p>

Note: Cable length: 3 m, 5 m, 10 m, 15 m, 20 m, 30 m, 40 m, 50 m
The empty boxes in the model number are put as follows: 3 m = 003, 5 m = 005, 10 m = 010.

Related Manuals

English Man.No.	Japanese Man.No.	Model	Manual name
I586	SBCE-377	R88M-1□/R88D-1SN□-ECT	AC Servomotors/Servo Drives 1S-Series with EtherCAT Communications User's Manual
W535	SBCA-418	NX701-□□□□	NX-series CPU Unit User's Manual (Hardware)
W578	SBCA-448	NX1P2-□□□□□□ NX1P2-□□□□□□1	NX-series NX1P2 CPU Unit User's Manual (Hardware)
W500	SBCA-358	NJ501-□□□□ NJ301-□□□□ NJ101-□□□□	NJ-series CPU Unit User's Manual (Hardware)
W501	SBCA-359	NX701-□□□□ NJ501-□□□□ NJ301-□□□□ NJ101-□□□□	NJ-series / NX-series CPU Unit User's Manual (Software)
W507	SBCE-363	NX701-□□□□ NJ501-□□□□ NJ301-□□□□ NJ101-□□□□	NJ-series / NX-series CPU Unit User's Manual (Motion Control)
Z930	SGFM-710	NX-SL□□□□ NX-SI□□□□ NX-SO□□□□	NX-series Safety Control Unit User's Manual
W504	SBCA-362	SYSMAC-SE2□□□	Sysmac Studio Version 1 Operation Manual
I589	SBCE-401	SYSMAC-SE2□□□	Sysmac Studio Drive Function Operation Manual
Z922	SJLB-306	G9SP-N10S G9SP-N10D G9SP-N20S	G9SP Series Safety Controller Operation Manual

AC Servo System 1S-series

Mechatronics Sizing Tool for AC Servo Motors

AC Servo motors selection for the entire machine

- User can size all axes in one project with the corresponded Sysmac controller.
- Pre-defined system can be used for common applications.
- Selection of optimized drive, motor and gearbox combination.
- Multiple views are not required: design, adjust and validate at a glance.
- Import sizing file directly to Sysmac Studio for reducing the machine development time.

Quick sizing and selection of AC servo motors

- High variety of mechanical system
- Import CAM from Sysmac Studio
- Kinematics chain architecture includes motor, reducer, loads and motion profile.
- Adjustments can be done in one view and results auto-refreshed.

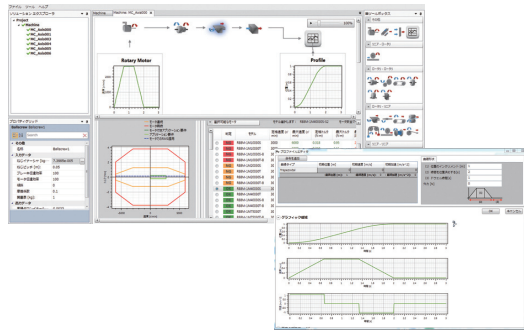

Re-use work done during design phase

- Export sizing file result.
- Import sizing file result in Sysmac Studio.
- EtherCAT configuration, axes settings and drives parameters will be created automatically

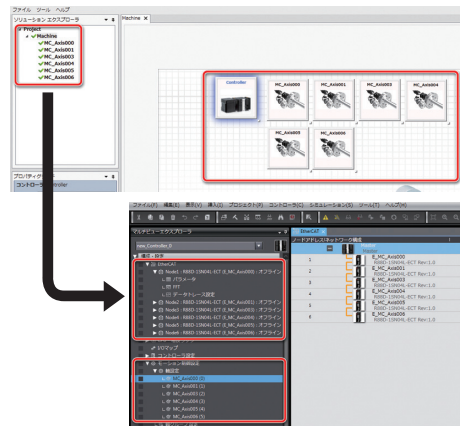

Compatible models

1S series	EtherCAT Communications	R88D-1SN□-ECT
G5 series	EtherCAT Communications for Position Control	R88D-KN□-ECT(-R)
G5 series	EtherCAT Communications (Linear Motor Type)	R88D-KN□-ECT-L
G5 series	MECHATROLINK-II Communications	R88D-KN□-ML2
G5 series	General-purpose Pulse Train or Analog Inputs	R88D-KT
G series	MECHATROLINK-II Communications	R88D-GN□-ML2
G series	General-purpose Pulse Train or Analog Inputs	R88D-GT
Smart Step 2	General-purpose Pulse Train	R7D-BP

Terms and Conditions Agreement

Read and Understand this Catalog

Please read and understand this catalog before purchasing the products. Please consult your OMRON representative if you have any questions or comments.

Warranty and Limitations of Liability

WARRANTY

- (a) Exclusive Warranty. Omron's exclusive warranty is that the Products will be free from defects in materials and workmanship for a period of twelve months from the date of sale by Omron (or such other period expressed in writing by Omron). Omron disclaims all other warranties, express or implied.
- (b) Limitations. OMRON MAKES NO WARRANTY OR REPRESENTATION, EXPRESS OR IMPLIED, ABOUT NON-INFRINGEMENT, MERCHANTABILITY OR FITNESS FOR A PARTICULAR PURPOSE OF THE PRODUCTS. BUYER ACKNOWLEDGES THAT IT ALONE HAS DETERMINED THAT THE PRODUCTS WILL SUITABLY MEET THE REQUIREMENTS OF THEIR INTENDED USE.

Omron further disclaims all warranties and responsibility of any type for claims or expenses based on infringement by the Products or otherwise of any intellectual property right. (c) Buyer Remedy. Omron's sole obligation hereunder shall be, at Omron's election, to (i) replace (in the form originally shipped with Buyer responsible for labor charges for removal or replacement thereof) the non-complying Product, (ii) repair the non-complying Product, or (iii) repay or credit Buyer an amount equal to the purchase price of the non-complying Product; provided that in no event shall Omron be responsible for warranty, repair, indemnity or any other claims or expenses regarding the Products unless Omron's analysis confirms that the Products were properly handled, stored, installed and maintained and not subject to contamination, abuse, misuse or inappropriate modification. Return of any Products by Buyer must be approved in writing by Omron before shipment. Omron Companies shall not be liable for the suitability or unsuitability or the results from the use of Products in combination with any electrical or electronic components, circuits, system assemblies or any other materials or substances or environments. Any advice, recommendations or information given orally or in writing, are not to be construed as an amendment or addition to the above warranty.

LIMITATIONS OF LIABILITY

OMRON COMPANIES SHALL NOT BE LIABLE FOR SPECIAL, INDIRECT, INCIDENTAL, OR CONSEQUENTIAL DAMAGES, LOSS OF PROFITS OR PRODUCTION OR COMMERCIAL LOSS IN ANY WAY CONNECTED WITH THE PRODUCTS, WHETHER SUCH CLAIM IS BASED IN CONTRACT, WARRANTY, NEGLIGENCE OR STRICT LIABILITY.

Further, in no event shall liability of Omron Companies exceed the individual price of the Product on which liability is asserted.

Application Considerations

SUITABILITY FOR USE

Omron Companies shall not be responsible for conformity with any standards, codes or regulations which apply to the combination of the Product in the Buyer's application or use of the Product. At Buyer's request, Omron will provide applicable third party certification documents identifying ratings and limitations of use which apply to the Product. This information by itself is not sufficient for a complete determination of the suitability of the Product in combination with the end product, machine, system, or other application or use. Buyer shall be solely responsible for determining appropriateness of the particular Product with respect to Buyer's application, product or system. Buyer shall take application responsibility in all cases.

NEVER USE THE PRODUCT FOR AN APPLICATION INVOLVING SERIOUS RISK TO LIFE OR PROPERTY OR IN LARGE QUANTITIES WITHOUT ENSURING THAT THE SYSTEM AS A WHOLE HAS BEEN DESIGNED TO ADDRESS THE RISKS, AND THAT THE OMRON

PROGRAMMABLE PRODUCTS

Omron Companies shall not be responsible for the user's programming of a programmable Product, or any consequence thereof.

Disclaimers

PERFORMANCE DATA

Data presented in Omron Company websites, catalogs and other materials is provided as a guide for the user in determining suitability and does not constitute a warranty. It may represent the result of Omron's test conditions, and the user must correlate it to actual application requirements. Actual performance is subject to the Omron's Warranty and Limitations of Liability.

CHANGE IN SPECIFICATIONS

Product specifications and accessories may be changed at any time based on improvements and other reasons. It is our practice to change part numbers when published ratings or features are changed, or when significant construction changes are made. However, some specifications of the Product may be changed without any notice. When in doubt, special part numbers may be assigned to fix or establish key specifications for your application. Please consult with your Omron's representative at any time to confirm actual specifications of purchased Product.

ERRORS AND OMISSIONS

Information presented by Omron Companies has been checked and is believed to be accurate; however, no responsibility is assumed for clerical, typographical or proofreading errors or omissions.

Note: Do not use this document to operate the Unit.

OMRON Corporation Industrial Automation Company
Kyoto, JAPAN

Contact: www.ia.omron.com

Regional Headquarters

OMRON EUROPE B.V.
Wegalaan 67-69, 2132 JD Hoofddorp
The Netherlands
Tel: (31)2356-81-300/Fax: (31)2356-81-388

OMRON ELECTRONICS LLC
2895 Greenspoint Parkway, Suite 200
Hoffman Estates, IL 60169 U.S.A.
Tel: (1) 847-843-7900/Fax: (1) 847-843-7787

OMRON ASIA PACIFIC PTE. LTD.
No. 438A Alexandra Road # 05-05/08 (Lobby 2),
Alexandra Technopark,
Singapore 119967
Tel: (65) 6835-3011/Fax: (65) 6835-2711

OMRON (CHINA) CO., LTD.
Room 2211, Bank of China Tower,
200 Yin Cheng Zhong Road,
PuDong New Area, Shanghai, 200120, China
Tel: (86) 21-5037-2222/Fax: (86) 21-5037-2200

Authorized Distributor:

© OMRON Corporation 2016-2018 All Rights Reserved.
In the interest of product improvement,
specifications are subject to change without notice.

CSM_5_3_0218
Cat. No. I821-E1-05

0418(0616)